

Rotating nut linear actuator

NS

Long Stroke and High-Speed Movement



Provides a Long Stroke and Speed Nearly as Fast as Linear Servo Actuators

Maximum Speed 2,400 mm/s, Maximum Acceleration 1 G, Maximum Stroke 3,000 mm



1 Moves the slider by rotating the nut, not the ball screw

The actuator is constructed with a fixed ball screw and a slider that moves linearly when its built-in hollow-shaft motor rotates the nut, instead of the nut moving linearly when the ball screw is rotated.

Since the ball screw is not rotated, the effects of dangerous rotation speeds are reduced, making high-speed movement possible even with a long stroke.

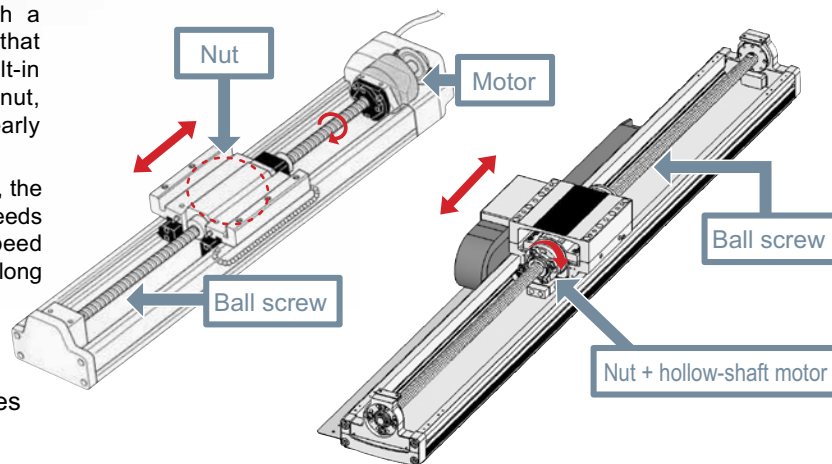

2 High-speed performance with a maximum speed of 2,400 mm/s and maximum acceleration of 1 G

A maximum speed of 2,400 mm/s is attained through the use of a high-lead precision screw (equivalent to C5). In addition, since there is minimal impact from dangerous rotation speeds, movement is possible at the maximum 2,400 mm/s, even at the maximum stroke (3,000 mm), greatly reducing the cycle time.

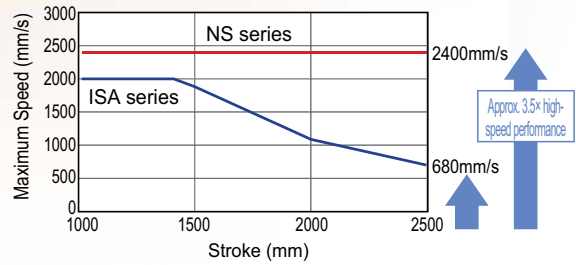

3 Long stroke of 3,000 mm achieved with Mid-Support Mechanisms

By equipping the NS series with mid-support mechanisms which proved well with the ISA series, deflection of the ball screw is suppressed and vibrations are reduced, allowing a stunning 3,000 mm stroke with a ball screw.

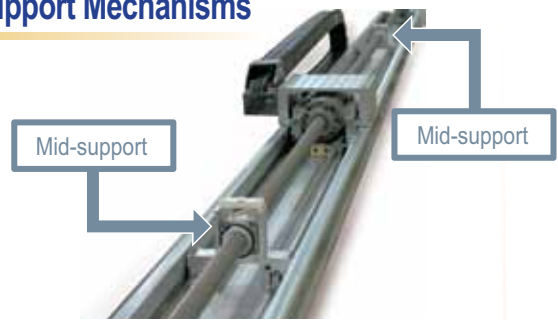

4 Multi-slider compatibility (equipped with collision prevention function)

The multi-slider type, which allows two sliders on a single axis to move independently, saves space and greatly reduces cycle time. In addition, the "collision prevention function", which prevents collisions between sliders, is standard with the XSEL and SSEL controllers.



5 Vertical type (brake as standard equipment)

A brake is installed as standard equipment on the vertical type to prevent the slider from falling if it is vertical when the unit is turned off. This is available with either a single slider or multiple sliders.

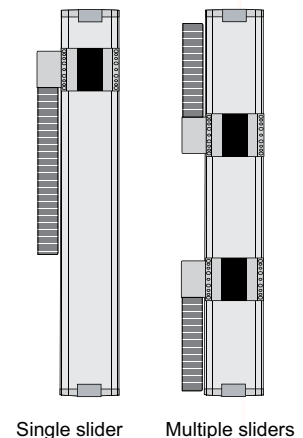

6 AQ seal as standard equipment, providing a long maintenance-free period

The AQ seal is a lubricating unit that contains a lubricant solidified with a resin. Lubricant is supplied to the guide and the ball screw over a long period of time, providing an extended maintenance-free period of 3 years or 5,000 km of operation with periodic applications of grease.

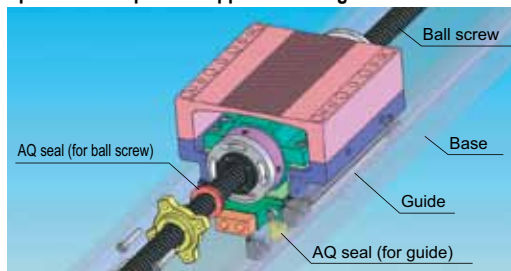





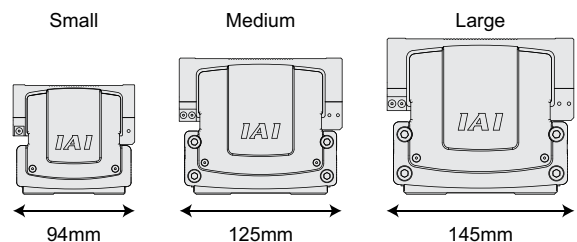

7 Multitude of variations

The extensive product line-up, which allows you to select specifications such as the size, slider type and installation direction, ensures the optimum configuration for any number of applications.

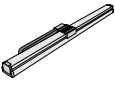
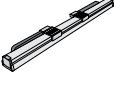

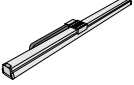
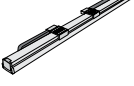
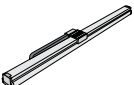
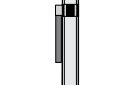
- Sizes: 3 types (small, medium and large)
- Sliders: 2 types (single slider and multiple sliders)
- Installation direction: 2 types (horizontal and vertical)
- Cable track installation direction: 4 directions
- Provided with mid-supports

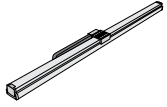
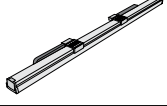
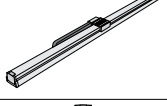
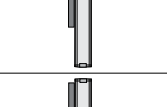
Specification Table

Size	Type	Slider	Appearance	Type	Encoder Type	Motor Type (W)	Lead (mm)	Stroke (mm)	Rated Thrust (N)	Maximum Payload (kg)	Maximum Speed (mm/s)	Reference Pages					
Small	Horizontal	Single Slider		SXMS	Absolute Incremental	60	12	400~800	70.8	15	720	→P7					
		Multi-Slider		SXMM				200~800				→P8					
	Vertical	Single Slider		SZMS				400~800		3	600	→P9					
		Multi-Slider		SZMM				200~800				→P10					
Medium	Horizontal	Single Slider		MXMS		Absolute Incremental	200	30	500~1500	113.9	25	1800	→P11				
		Multi-Slider		MXMM				20		170.9	40	1200					
		Horizontal/ With Mid- supports	Single Slider					MXMS	30	1600~2200	113.9	25	1800	→P13			
			Multi-Slider					MXMM	20		170.9	40	1200				
	Vertical	Single Slider		MZMS	20			500~800	170.9	6	1000	→P14					
		Multi-Slider		MZMM								300~800	→P15				
		Horizontal	Single Slider					LXMS					40	500~2200	170	40	2400
			Multi-Slider					LXMM				20	340.1		80	1300	
Large	Horizontal/ With Mid- supports	Single Slider		LXMS	Absolute Incremental	400	40	2300~3000	170	40	2400	→P18					
		Multi-Slider		LXMM					20	340.1	80		1300				
		Vertical	Single Slider					LZMS	20	500~1000	340.1	16	1000	→P19			
			Multi-Slider					LZMM						250~950	→P20		

Model

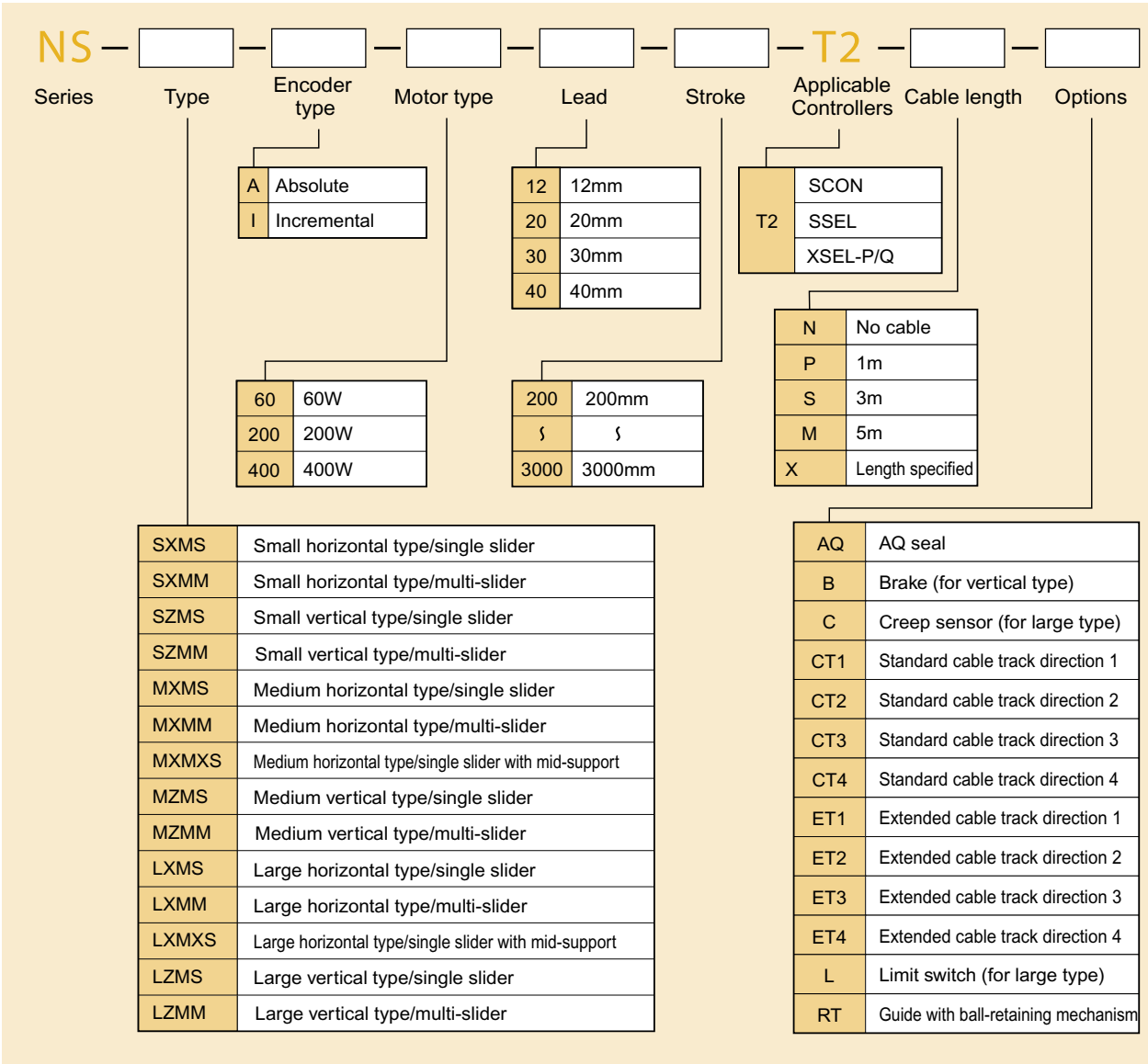

Table of Mass Capacities by Acceleration Condition

1. Horizontal Installation

Type	Mid-Support	Motor Output (W)	Lead (mm)	Maximum Speed (mm/s)	Maximum Acceleration (G)	Load Capacity by Acceleration (kg)							
						0.3G	0.4G	0.5G	0.6G	0.7G	0.8G	0.9G	1.0G
Small	No	60	12	720	0.8	15	7	5	3	1	0.5	—	—
			30	1800	1.0	25	16	10	6	3.5	2	1	0.5
Medium	No	200	20	1200	0.8	40	28	18	10	5	2.5	—	—
			30	1800	0.3	25	—	—	—	—	—	—	—
Large	No	400	20	1200		1.0	40	—	—	—	—	—	—
			40	2400	40		30	25	20	17	15	13	10
Large	Yes	400	40	2400	0.3	40	60	48	40	34	30	27	24
			20	1300		80	—	—	—	—	—	—	—

2. Vertical Installation

Type	Mid-Support	Motor Output (W)	Lead (mm)	Maximum Speed (mm/s)	Maximum Acceleration (G)	Load Capacity by Acceleration (kg)							
						0.3G	0.4G	0.5G	0.6G	0.7G	0.8G	0.9G	1.0G
Small	No	60	12	600	0.7	3	2	1.5	1	0.5	—	—	—
Medium	No	200	20	1000	0.5	6	4	3	—	—	—	—	—
Large	No	400	20	1000	0.8	16	12.3	11.1	10.1	9.2	6	—	—

Details of Main Unit Options

AQ Seal (Standard Equipment)

Model **AQ**

Details

The AQ seal is a lubricated unit using lubricated materials in which a lubricant is solidified with a resin.

The lubricant is supplied when the AQ seal contacts the guide and the ball screw thread, making it maintenance-free for a long period with the application of grease. (Standard equipment for all models)

Brake (Standard Equipment for Vertical Type)

Model **B**

Details

This is a holding mechanism to prevent the slider from falling and damaging installed items when the power or the servo is off when the actuator is used at a vertical position. (Standard equipment for the vertical type/No brake for the horizontal type.) *A brake box is attached for the MZMS/MZMM/LZMS/LXMM types. (See P21)

Creep Sensor (Only for Large type) *Not supported for Small/Medium types.

Model **C**

Details

When the homing operation is carried out with the incremental specifications, in order to shorten the homing time, the slider is moved at high speed to just before the position and when it passes this sensor, the speed is dropped to resume normal homing operations. Since this sensor is mounted within the actuator itself, it does not affect the appearance or external dimensions.

Installation Direction of Standard Cable Track/Installation Direction of Expanded Cable Track

Model **CT1/CT2/CT3/CT4 (Installation direction of standard cable track)**
ET1/ET2/ET3/ET4 (Installation direction of extended cable track)

Details

The installation directions for cable tracks can be selected from the four types shown below, including the standard installation direction. (the body base has a reamer hole on the right side and a long hole on the left side).

In addition, if the capacity is insufficient for the standard cable track, an extended cable track with increased capacity can be selected.

Note 1: The cable track can be installed in one direction only for the multi-slider type.

Note 2: For NS-S and NS-M, the extended cable cannot be selected.

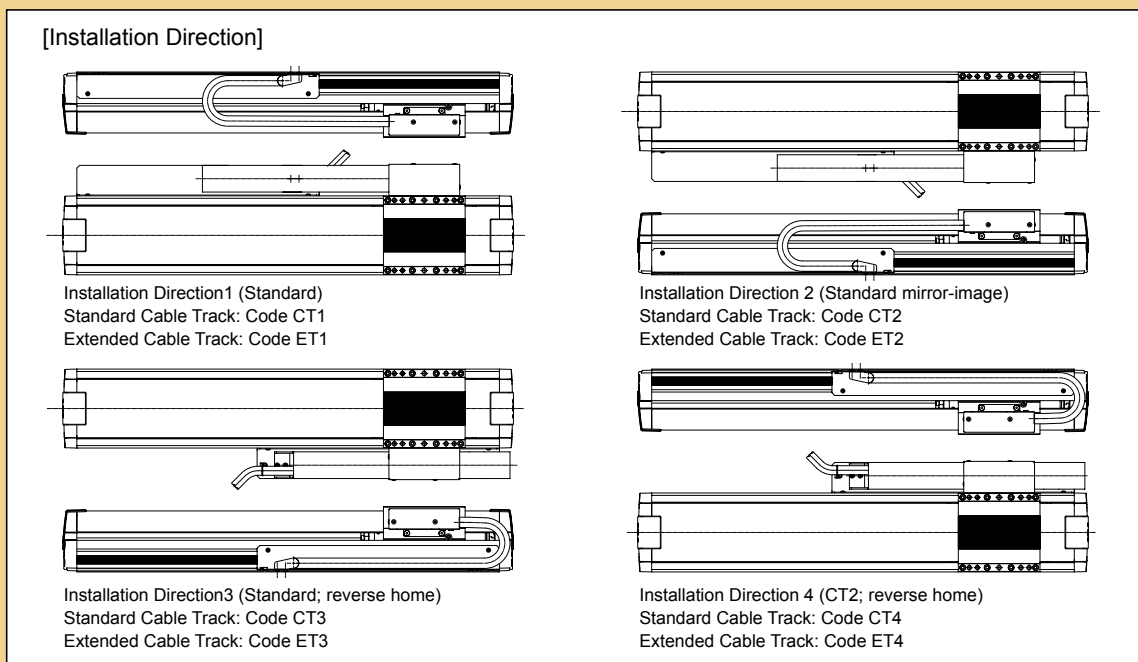

Origin Point Limit Switch (For Large type)

*Not supported for Small/Medium types.

Model **L**

Details

For the normal homing operation in the NS series, the "pressing method" is employed, wherein the slider is pressed against the stopper to detect the Z phase after reversing and to decide the home position.

The L option (Home Limit Switch) for this homing operation detects and reverses using the proximity sensor instead of the pressing method. Since this sensor is mounted within the actuator itself, it does not affect the appearance or external dimensions.

Guide with Ball-retaining Mechanism (Standard Equipment)

Model **RT**

Details

This is a ball-retaining mechanism for eliminating collisions between balls to provide a long maintenance-free period and long life by inserting a spacer (a retaining device) between the guide balls (steel balls) (Standard equipment for all models)

Internal Dimensions of Cable Track

Small

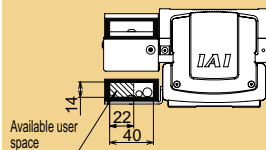

Medium

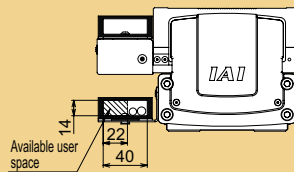

Regarding the outer diameter and the number of cables to be stored

- (1) Make gaps of at least 2 mm between the outer diameter and the inside wall of the cable and between the cables.
- (2) The outer diameter of the cables should be $\phi 12$ or less and they should be arranged and used horizontally so that they do not cross each other.
- (3) Note that the life of the cables may be extremely shortened due to forces applied on the cables if the number of cables stored exceeds the specification.

Large

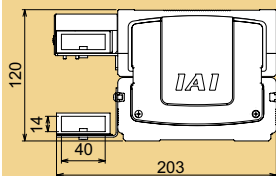

<<Standard Cable Track>>

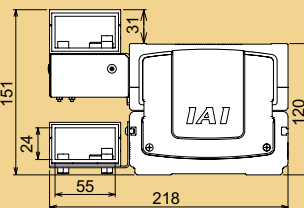

<<Extended Cable Track>>

Regarding the outer diameter and the number of cables to be stored

- (1) Make gaps of at least 2 mm between the outer diameter and the inside wall of the cable and between the cables.
- (2) For the cables, the outer diameter of the standard cable track should be $\phi 12$ or less and that of the extended cable track should be $\phi 16.8$ or less. They should be arranged and used horizontally so that they do not cross each other.
- (3) Note that the life of the cables may be extremely shortened due to forces applied on the cables if the number of cables stored exceeds the specification.

NS-SXMS

Single-Axis Robot Small Nut Rotation Type Main Unit Width 94mm 60W
Horizontal Type Single Slider



■Model **NS — SXMS — [] — 60 — [] — [] — T2 — [] — AQ — [] — RT**

Series Type Encoder Type Motor Type Lead Stroke Applicable Controller Cable Length Option

A: Absolute 60: 60W 12: 12 mm 400: 400mm T2: SCON N: No See the options table below
 1: Incremental SSEL S: 3m
 XSEL-P/Q M: 5m
 X[]: Length Specified

Model/Specification

Model	Encoder Type	Motor Output (W)	Lead (mm)	Stroke (mm)	Speed (mm/s)	Acceleration (Note 1)				Payload Capacity (Note 1 & 2)				Rated Thrust (N)
						Horizontal(G)		Vertical(G)		Horizontal(kg)		Vertical(kg)		
						Rated	Maximum	Rated	Maximum	Rated Acceleration	Maximum Acceleration	Rated Acceleration	Maximum Acceleration	
NS-SXMS-[]-60-12-[]-T2-[]-AQ-[]-RT	Absolute Incremental	60	12	400~800	720	0.3	0.8	Horizontal Only	15	0.5	Horizontal Only	70.8		

*In the model above, [] indicates the type of encoder, [] indicates the stroke, [] indicates the cable length, and [] indicates the option.

Option

Name	Model	Reference page	Note
AQ Seal	AQ	→P5	Standard Equipment
Installation Direction of Standard Cable Track	CT1~CT4	→P5	Enter CT1 for standard installation
Guide with Ball-Retaining Mechanism	RT	→P6	Standard Equipment

Common specifications

Driving Method	Ball Thread, Diameter $\phi 10$ mm, Equivalent to Rolled C10
Repeated Positioning Accuracy	+/- 0.02mm
Backlash	0.05mm or less
Guide	Integrated to Base
Dynamic Allowable Moment(Note 3)	Ma:28.4N·m Mb:40.2N·m Mc:65.7N·m
Overhung load length	Ma Direction: 450mm or less; Mb and Mc Direction: 450mm or less
Base	Material: Aluminium, White Alumite Treatment
Cable Length (Note 4)	N: No cable; S: 3 m; M: 5 m; X[]: Length specified
Ambient Temperature	0~40 degrees Celsius, 85% RH or less (No condensation)

Dimensional drawing

The CAD drawings can be downloaded from our homepage.

2D CAD

*1 Connects motor cables and encoder cables.
For details on cables, please see page 22.

SE: Stroke End
ME: Mechanical End

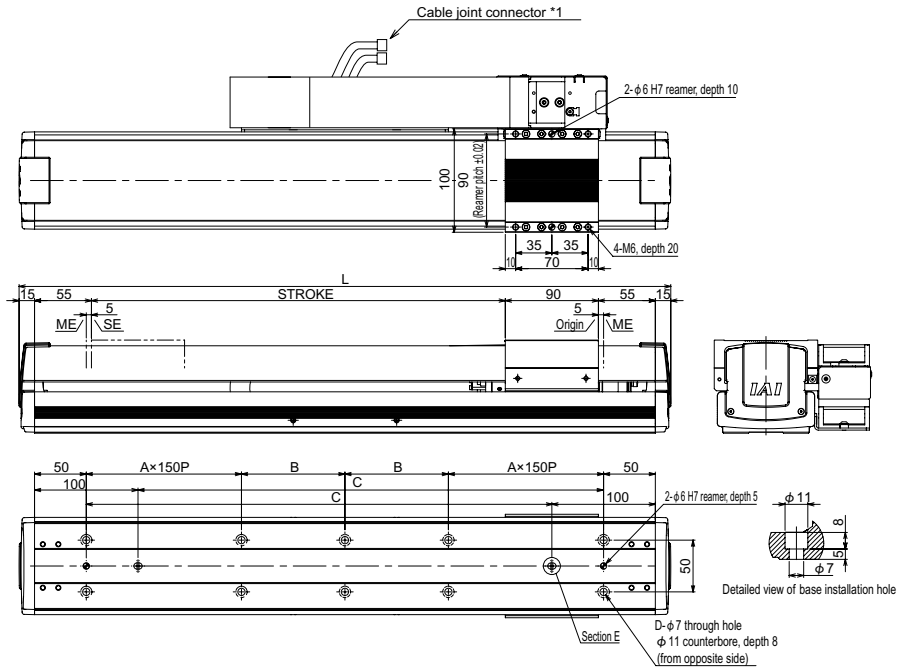
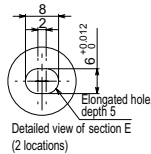
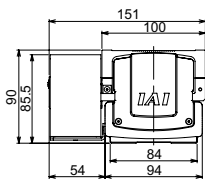

*For the internal dimensions of the cable track, please see page 6.

Stroke	400	500	600	700	800
L	630	730	830	930	1030
A	1	1	1	2	2
B	100	150	200	100	150
C	450	550	650	750	850
D	10	10	10	14	14
Mass(kg)	5.8	6.5	7.1	7.8	8.4

Applicable Controller Specifications

Applicable Controller	Max. Number of Axes Controlled	Compatible Encoder Type	Operation Method	Power/Voltage
X-SEL-P/Q	6 axis	Absolute/ Incremental	Programs Positioner Pulse Train Control	Three-Phase/ Single-Phase 200VAC
SSEL	2 axis			Single-Phase 100/200VAC
SCON	1 axis			



Note

(Note 1) For the relationship between acceleration and payload capacity, see page 4.
 (Note 2) The values shown are payload capacities during operation at maximum speed.
 (Note 3) For a 10,000-km running life.
 (Note 4) The maximum cable length is 30 m. Please specify length in meters.
 (E.g., X08 = 8 m)

NS-SXMM

Single-Axis Robot Small Nut Rotation Type Main Unit Width 94mm 60W
Horizontal Type Multi-Slider

Model **NS** - **SXMM** - - **60** - - - **T2** - - **AQ** - **CT1** - **RT**

Series Type Encoder Type Motor Type Lead Stroke Applicable controller Cable Length

A: Absolute 60: 60W 12: 12 mm 200: 200mm T2: SCON N: No S: 3m

I: Incremental 800: 800mm XSEL-P/Q M: 5m X□□: Length Specified

See the options table below



Model/Specification

Model	Encoder Type	Motor Output (W)	Lead (mm)	Stroke (mm)	Speed (mm/s)	Acceleration (Note 1)				Payload Capacity (Note 1 & 2)				Rated Thrust (N)
						Horizontal (G)		Vertical (G)		Horizontal (kg)		Vertical (kg)		
						Rated	Maximum	Rated	Maximum	Rated	Maximum	Rated	Maximum	
NS-SXMM- -60-12- -T2- -AQ- -RT	Absolute Incremental	60	12	200-800	720	0.3	0.8	Horizontal Only	15	0.5	Horizontal Only	70.8		

*In the model above, indicates the type of encoder, indicates the stroke, indicates the cable length, and indicates the option.

Option

Name	Model	Reference page	Note
AQ Seal	AQ	→P5	Standard Equipment
Installation Direction of Standard Cable Track	CT1	→P5	CT1 for standard
Guide with Ball-Retaining Mechanism	RT	→P6	Standard Equipment

Common specifications

Driving Method	Ball Thread, Diameter φ10 mm, Equivalent to Rolled C10
Repeated Positioning Accuracy	+/- 0.02mm
Backlash	0.05mm or less
Guide	Integrated to Base
Dynamic Allowable Moment (Note 3)	Ma:28.4N·m Mb:40.2N·m Mc:65.7N·m
Overhung load length	Ma Direction: 450mm or less; Mb and Mc Direction: 450mm or less
Base	Material: Aluminium, White Alumite Treatment
Cable Length (Note 4)	N: No cable; S: 3 m; M: 5 m; X□□: Length specified
Ambient Temperature	0~40 degrees Celsius, 85% RH or less (No condensation)

Dimensional drawing

The CAD drawings can be downloaded from our homepage.

2D CAD

*1 Connects motor cables and encoder cables.
For details on cables, please see page 22.

SE: Stroke End
ME: Mechanical End

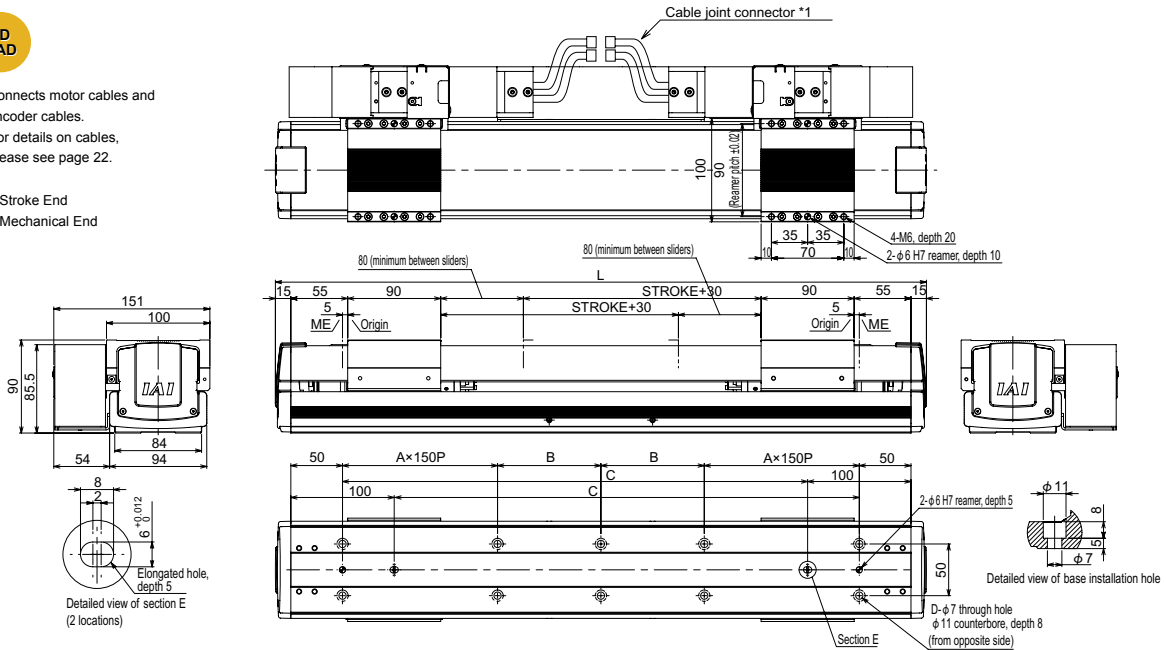

*For the internal dimensions of the cable track, please see page 6.

Stroke	200	300	400	500	600	700	800
L	630	730	830	930	1030	1130	1230
A	1	1	1	2	2	2	2
B	100	150	200	100	150	200	100
C	450	550	650	750	850	950	1050
D	10	10	10	14	14	14	18
Mass (kg)	7.5	8.1	8.7	9.4	10.0	10.7	11.3

Applicable Controller Specifications

Applicable Controller	Max. Number of Axes Controlled	Compatible Encoder Type	Operation Method	Power/Voltage
X-SEL-P/Q	6 axis	Absolute/Incremental	Programs Positioner Pulse Train Control	Three-Phase/Single-Phase 200VAC Single-Phase 100/200VAC
SSEL	2 axis			
SCON	1 axis			

Note: A two-axis controller is required to operate the multi-slider.
Two controllers are required for SCON.
(Please note that SCON does not have a collision prevention mechanism)



Note

(Note 1) For the relationship between acceleration and payload capacity, see page 4.
(Note 2) The values shown are payload capacities during operation at maximum speed.
(Note 3) For a 10,000-km running life.
(Note 4) The maximum cable length is 30 m. Please specify length in meters.
(E.g., X08 = 8 m)

NS-SZMS

Single-Axis Robot Small Nut Rotation Type Main Unit Width 94mm 60W
Vertical Type Single Slider



■Model **NS — SZMS** — [] — **60** — [] — [] — **T2** — [] — **AQ** — **B** — [] — **RT**

Series Type Encoder Type Motor Type Lead Stroke Applicable controller Cable Length
 A: Absolute 60: 60W 12: 12 mm 400: 400mm T2: SCON N: No
 I: Incremental SSEL S: 3m
 XSEL-P/Q M: 5m
 X□: Length Specified

See the options table below

Model/Specification

Model	Encoder Type	Motor Output (W)	Lead (mm)	Stroke (mm)	Speed (mm/s)	Acceleration (Note 1)				Payload Capacity (Note 1 & 2)				Rated Thrust (N)
						Horizontal (G)		Vertical (G)		Horizontal (kg)		Vertical (kg)		
						Rated	Maximum	Rated	Maximum	Rated	Maximum	Rated	Maximum	
NS-SZMS-①-60-12-②-T2-③-AQ-④-RT	Absolute Incremental	60	12	400~800	600	Vertical Only	0.3	0.7	Vertical Only	3	0.5	70.8		

*In the model above, ① indicates the type of encoder, ② indicates the stroke, ③ indicates the cable length, and ④ indicates the option.

Option

Name	Model	Reference page	Note
AQ Seal	AQ	→P5	Standard Equipment
Brake	B	→P5	Standard Equipment
Installation Direction of Standard Cable Track	CT1-CT4	→P5	Enter CT1 for standard installation
Guide with Ball-Retaining Mechanism	RT	→P6	Standard Equipment

Common specifications

Driving Method	Ball Thread, Diameter $\phi 10$ mm, Equivalent to Rolled C10
Repeated Positioning Accuracy	+/- 0.02mm
Backlash	0.05mm or less
Guide	Integrated to Base
Dynamic Allowable Moment (Note 3)	Ma: 28.4 N·m, Mb: 40.2 N·m, Mc: 33.3N·m
Overhung load length	Ma Direction: 450mm or less; Mb and Mc Direction: 450mm or less
Base	Material: Aluminium, White Alumite Treatment
Cable Length (Note 4)	N: No cable; S: 3 m; M: 5 m; X□: Length specified
Ambient Temperature	0~40 degrees Celsius, 85% RH or less (No condensation)

Dimensional drawing

The CAD drawings can be downloaded from our homepage.

2D CAD

*1 Connects motor cables and encoder cables.
For details on cables, please see page 22.

SE: Stroke End
ME: Mechanical End

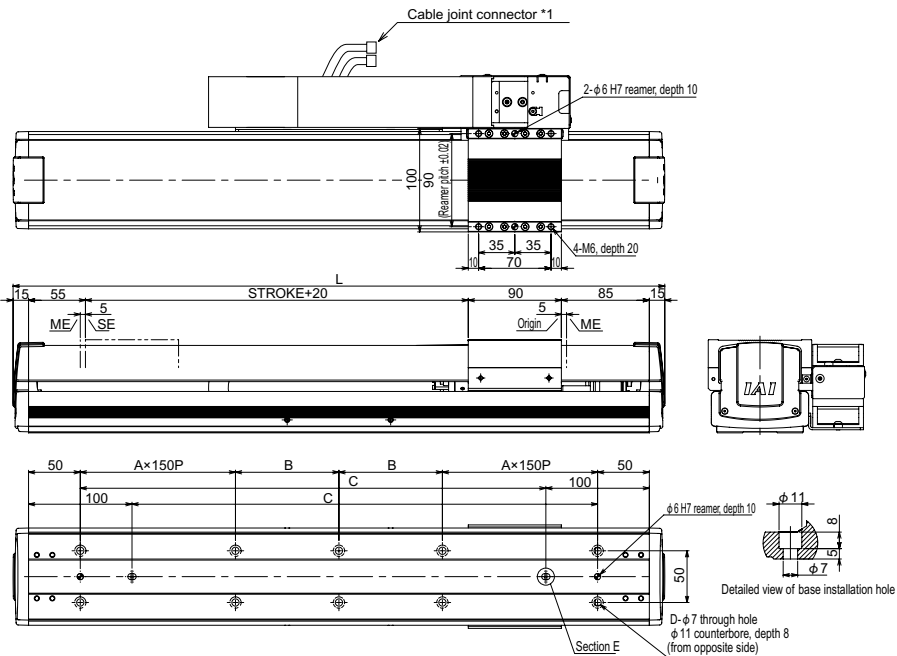
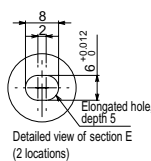
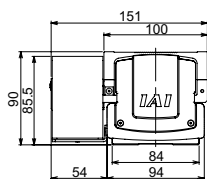

*For the internal dimensions of the cable track, please see page 6.

Stroke	400	500	600	700	800
L	680	780	880	980	1080
A	1	1	1	2	2
B	125	175	225	125	175
C	500	600	700	800	900
D	10	10	10	14	14
Mass (kg)	6.2	6.8	7.4	8.1	8.7

Applicable Controller Specifications

Applicable Controller	Max. Number of Axes Controlled	Compatible Encoder Type	Operation Method	Power/Voltage
X-SEL-P/Q	6 axis	Absolute/Incremental	Programs Positioner Pulse Train Control	Three-Phase/Single-Phase 200VAC
SSEL	2 axis			Single-Phase
SCON	1 axis			100/200VAC



Note

(Note 1) For the relationship between acceleration and payload capacity, see page 4.
 (Note 2) The values shown are payload capacities during operation at maximum speed.
 (Note 3) For a 10,000-km running life.
 (Note 4) The maximum cable length is 30 m. Please specify length in meters.
 (E.g., X08 = 8 m)

NS-SZMM Single-Axis Robot Small Nut Rotation Type Main Unit Width 94mm 60W Vertical Type Multi-Slider



■ Model **NS — SZMM — □ — 60 — □ — □ — T2 — □ — AQ — B — CT1 — RT**

Series	Type	Encoder Type	Motor Type	Lead	Stroke	Applicable controller	Cable Length
NS	SZMM	A: Absolute I: Incremental	60: 60W 12: 12 mm	200: 200mm 800: 800mm	T2: SCON SSEL XSEL-P/Q	N: No S: 3m M: 5m X□: Length Specified	

See the options table below

Model/Specification

Model	Encoder Type	Motor Output (W)	Lead (mm)	Stroke (mm)	Speed (mm/s)	Acceleration (Note 1)				Payload Capacity (Note 1 & 2)				Rated Thrust (N)
						Horizontal (G)		Vertical (G)		Horizontal (kg)		Vertical (kg)		
						Rated	Maximum	Rated	Maximum	Rated Acceleration	Maximum Acceleration	Rated Acceleration	Maximum Acceleration	
NS-SZMM-□-60-12-□-□-□-□-□-□-RT	Absolute Incremental	60	12	200-800	600	Vertical Only	0.3	0.7	Vertical Only	3	0.5	70.8		

*In the model above, □ indicates the type of encoder, □ indicates the stroke, □ indicates the cable length, and □ indicates the option.

Option

Name	Model	Reference page	Note
AQ Seal	AQ	→P5	Standard Equipment
Brake	B	→P5	Standard Equipment
Installation Direction of Standard Cable Track	CT1	→P5	CT1 for standard
Guide with Ball-Retaining Mechanism	RT	→P6	Standard Equipment

Common specifications

Driving Method	Ball Thread, Diameter ϕ 10 mm, Equivalent to Rolled C10
Repeated Positioning Accuracy	\pm 0.02mm
Backlash	0.05mm or less
Guide	Integrated to Base
Dynamic Allowable Moment (Note 3)	Ma: 28.4 N·m, Mb: 40.2 N·m, Mc: 33.3N·m
Overhung load length	Ma Direction: 450mm or less; Mb and Mc Direction: 450mm or less-
Base	Material: Aluminium, White Alumite Treatment
Cable Length (Note 4)	N: No cable; S: 3 m; M: 5 m; X□: Length specified
Ambient Temperature	0-40 degrees Celsius, 85% RH or less (No condensation)

Dimensional drawing

The CAD drawings can be downloaded from our homepage.

2D CAD

*1 Connects motor cables and encoder cables.
For details on cables, please see page 22.

SE: Stroke End
ME: Mechanical End

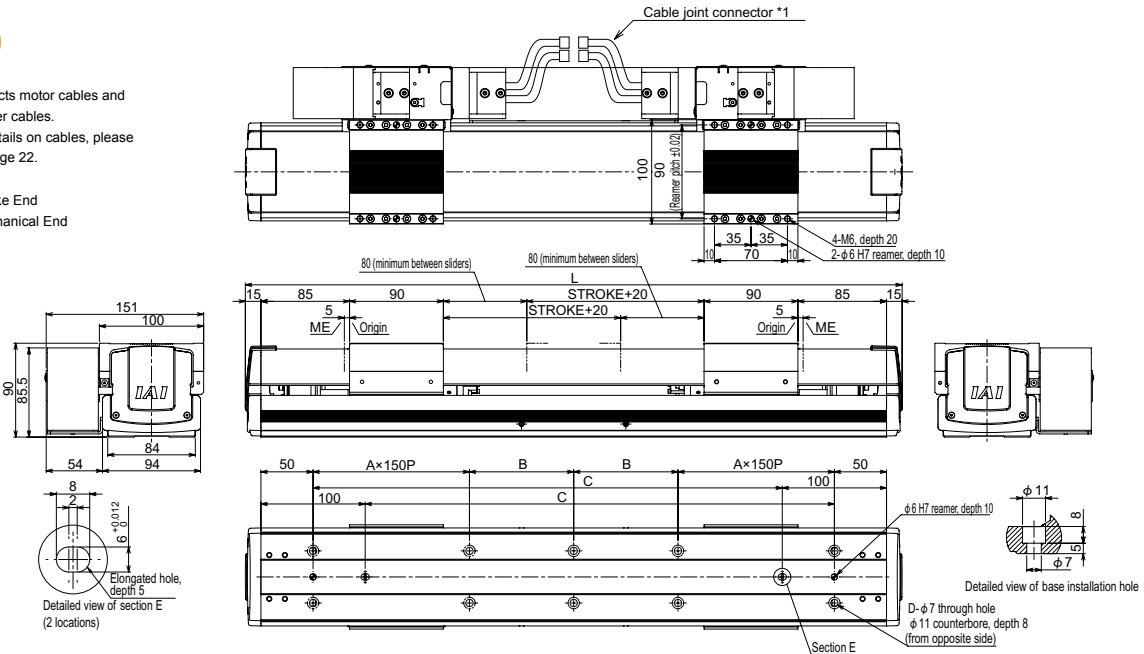

*For the internal dimensions of the cable track, please see page 6.

Stroke	200	300	400	500	600	700	800
L	680	780	880	980	1080	1180	1280
A	1	1	1	2	2	2	3
B	125	175	225	125	175	225	125
C	500	600	700	800	900	1000	1100
D	10	10	10	14	14	14	18
Mass (kg)	7.7	8.4	9.0	9.7	10.3	10.9	11.6

Applicable Controller Specifications

Applicable Controller	Max. Number of Axes Controlled	Compatible Encoder Type	Operation Method	Power/Voltage
X-SEL-P/Q	6 axis	Absolute/ Incremental	Programs Positioner Pulse Train Control	Three-Phase/ Single-Phase 200VAC
SSEL	2 axis			Single-Phase
SCON	1 axis			100/200VAC

Note: A two-axis controller is required to operate the multi-slider.
Two controllers are required for SCON.
(Please note that SCON does not have a collision prevention mechanism)



Note

(Note 1) For the relationship between acceleration and payload capacity, see page 4.
(Note 2) The values shown are payload capacities during operation at maximum speed.
(Note 3) For a 10,000-km running life.
(Note 4) The maximum cable length is 30 m. Please specify length in meters.
(E.g., X08 = 8 m)

NS-MXMS

Single-Axis Robot Medium Nut Rotation Type Main Unit Width 125mm 200W
Horizontal Type Single Slider



Model: **NS** — **MXMS** — — **200** — — — **T2** — — **AQ** — — **RT**

Series	Type	Encoder Type	Motor Type	Lead	Stroke	Applicable controller	Cable Length	Option
A: Absolute I: Incremental	200: 200W	30: 30mm 20: 20 mm	500: 500mm 1500: 1,500mm	T2: SCON SSEL XSEL-P/Q	N: No S: 3m M: 5m X□□: Length Specified		See the options table below	

Model/Specification

Model	Encoder Type	Motor Output (W)	Lead (mm)	Stroke (mm)	Speed (mm/s)	Acceleration (Note 1)				Payload capacity (Note 1 & 2)				Rated Thrust (N)
						Horizontal (G)		Vertical (G)		Horizontal (kg)		Vertical (kg)		
						Rated	Maximum	Rated	Maximum	Rated	Maximum	Rated	Maximum	
NS-MXMS- <input type="checkbox"/> -200-30- <input type="checkbox"/> -T2- <input type="checkbox"/> -AQ- <input type="checkbox"/> -RT	Absolute	200	30	500~1500	1800	0.3	1.0	Horizontal Only		25	0.5	Horizontal Only		113.9
NS-MXMS- <input type="checkbox"/> -200-20- <input type="checkbox"/> -T2- <input type="checkbox"/> -AQ- <input type="checkbox"/> -RT	Incremental		20		1200	0.3	0.8			40	2.5			170.9

*In the model above, indicates the type of encoder, indicates the stroke, indicates the cable length, and indicates the option.

Option

Name	Model	Reference page	Note
AQ Seal	AQ	→P5	Standard Equipment
Installation Direction of Standard Cable Track	CT1~CT4	→P5	Enter CT1 for standard installation
Guide with Ball-Retaining Mechanism	RT	→P6	Standard Equipment

Common specifications

Driving Method	Ball Thread, Diameter $\phi 16$ mm, Equivalent to Rolled C5
Repeated Positioning Accuracy	+/- 0.01 mm
Backlash	0.02 mm or less
Guide	Integrated to Base
Dynamic Allowable Moment (Note 3)	Ma: 69.6N·m, Mb: 99.0N·m, Mc: 161.7N·m
Overhung load length	Ma Direction: 600mm or less; Mb and Mc Direction: 600mm or less
Base	Material: Aluminium, White Alumite Treatment
Cable Length (Note 4)	N: No cable; S: 3 m; M: 5 m; X□□: Length specified
Ambient Temperature	0~40 degrees Celsius, 85% RH or less (No condensation)

Dimensional drawing

The CAD drawings can be downloaded from our homepage.

2D CAD

*1 Connects motor cables and encoder cables.
For details on cables, please see page 22.

SE: Stroke End
ME: Mechanical End

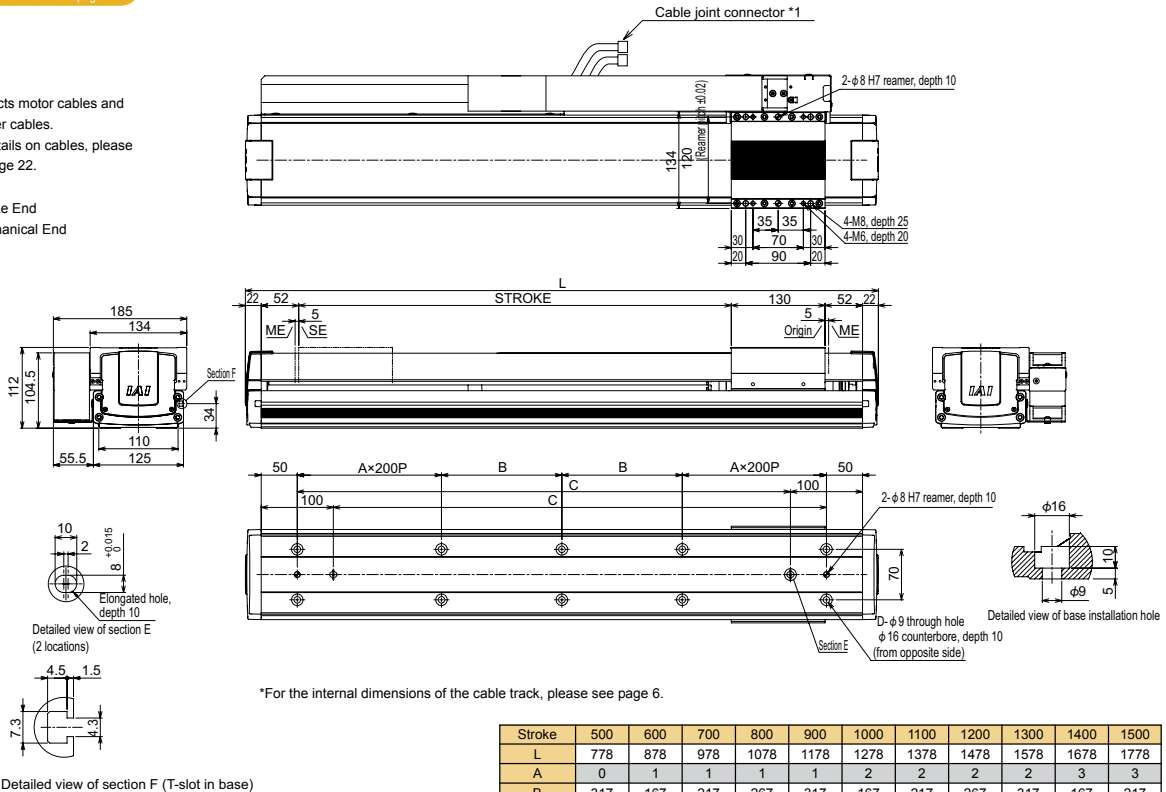

Stroke	500	600	700	800	900	1000	1100	1200	1300	1400	1500
L	778	878	978	1078	1178	1278	1378	1478	1578	1678	1778
A	0	1	1	1	1	2	2	2	2	3	3
B	317	167	217	267	317	167	217	267	317	167	217
C	584	684	784	884	984	1084	1184	1284	1384	1484	1584
D	6	10	10	10	10	14	14	14	14	18	18
Mass (kg)	11.9	13.1	14.4	15.6	16.8	18.0	19.3	20.5	21.7	23.0	24.2

Applicable Controller Specifications

Applicable Controller	Max. Number of Axes Controlled	Compatible Encoder Type	Operation Method	Power/Voltage
X-SEL-P/Q	6 axis	Absolute/ Incremental	Programs	Three-Phase/ Single-Phase 200V AC
SSEL	2 axis		Positioner Pulse Train Control	Single-Phase 100/200VAC
SCON	1 axis			



Note

(Note 1) For the relationship between acceleration and payload capacity, see page 4.
(Note 2) The values shown are payload capacities during operation at maximum speed.
(Note 3) For a 10,000-km running life.
(Note 4) The maximum cable length is 30 m. Please specify length in meters. (E.g., X08 = 8 m)
(Note 5) When an axis with a long stroke (1,300 mm or more) is used hanging from the ceiling, the cover of the body may hang down and contact the slider. Therefore, in cases of such use, please contact our sales representative in advance.

NS-MXMM

Single-Axis Robot Medium Nut Rotation Type Main Unit Width 125mm 200W
Horizontal Type Multi-Slider

Model: **NS** - **MXMM** - - **200** - - - **T2** - - **AQ** - **CT1** - **RT**

Series	Type	Encoder Type	Motor Type	Lead	Stroke	Applicable controller	Cable Length	Option
A: Absolute I: Incremental	200: 200W	30: 30mm 20: 20mm	300: 300mm 1500: 1,500mm	T2: SCON SSEL XSEL-P/Q	N: No S: 3m M: 5m X□: Length Specified	See the options table below		



Model/Specification

Model	Encoder Type	Motor Output (W)	Lead (mm)	Stroke (mm)	Speed (mm/s)	Acceleration (Note 1)				Payload capacity (Note 1 & 2)				Rated Thrust (N)
						Horizontal (G)		Vertical (G)		Horizontal (kg)		Vertical (kg)		
						Rated	Maximum	Rated	Maximum	Rated	Maximum	Rated	Maximum	
NS-MXMM- -200-30- -T2- -AQ- -RT	Absolute	200	30	300~1500	1800	0.3	1.0	Horizontal Only		25	0.5	Horizontal Only		113.9
NS-MXMM- -200-20- -T2- -AQ- -RT	Incremental		20		1200	0.3	0.8			40	2.5			170.9

*In the model above, indicates the type of encoder, indicates the stroke, indicates the cable length, and indicates the option.

Option

Name	Model	Reference page	Note
AQ Seal	AQ	→P5	Standard Equipment
Installation Direction of Standard Cable Track	CT1	→P5	CT1 for standard
Guide with Ball-Retaining Mechanism	RT	→P6	Standard Equipment

Common specifications

Driving Method	Ball Thread, Diameter φ16 mm, Equivalent to Rolled C5
Repeated Positioning Accuracy	+/- 0.01 mm
Backlash	0.02 mm or less
Guide	Integrated to Base
Dynamic Allowable Moment (Note 3)	Ma: 69.6N·m, Mb: 99.0N·m, Mc: 161.7N·m
Overhung load length	Ma Direction: 600mm or less; Mb and Mc Direction: 600mm or less
Base	Material: Aluminium, White Alumite Treatment
Cable Length (Note 4)	N: No cable; S: 3 m; M: 5 m; X□: Length specified
Ambient Temperature	0~40 degrees Celsius, 85% RH or less (No condensation)

Dimensional drawing

The CAD drawings can be downloaded from our homepage.

2D CAD

*1 Connects motor cables and encoder cables.
For details on cables, please see page 22.

SE: Stroke End
ME: Mechanical End

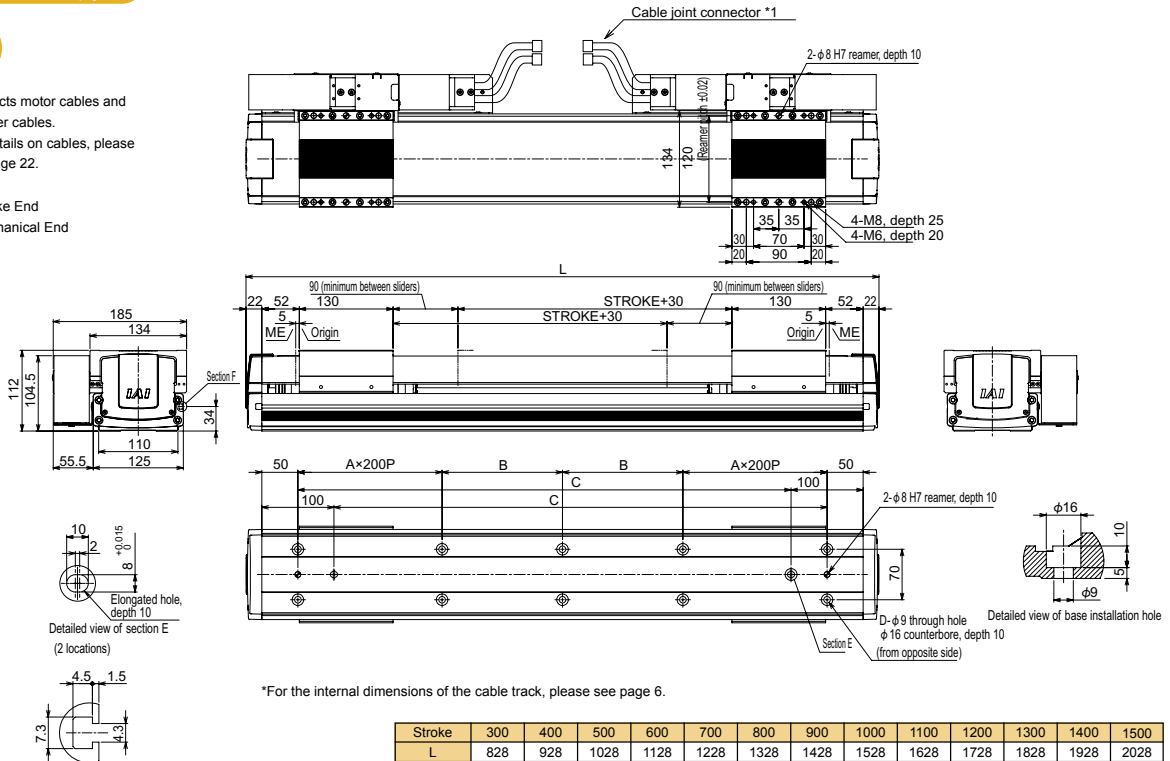

Stroke	300	400	500	600	700	800	900	1000	1100	1200	1300	1400	1500
L	828	928	1028	1128	1228	1328	1428	1528	1628	1728	1828	1928	2028
A	1	1	1	1	2	2	2	2	3	3	3	3	4
B	142	192	242	292	142	192	242	292	142	192	242	292	142
C	634	734	834	934	1034	1134	1234	1334	1434	1534	1634	1734	1834
D	10	10	10	10	14	14	14	14	18	18	18	18	22
Mass (kg)	15.6	16.8	18	19.2	20.5	21.7	22.9	24.2	25.4	26.6	27.9	29.1	30.3

Applicable Controller Specifications

Applicable Controller	Max. Number of Axes Controlled	Compatible Encoder Type	Operation Method	Power/Voltage
X-SEL-P/Q	6 axis	Absolute/ Incremental	Programs	Three-Phase/ Single-Phase 200VAC
SSEL	2 axis			Single-Phase 100/200VAC
SCON	1 axis		Positioner Pulse Train Control	

Note: A two-axis controller is required to operate the multi-slider.
Two controllers are required for SCON.
(Please note that SCON does not have a collision prevention mechanism)



Note

(Note 1) For the relationship between acceleration and payload capacity, see page 4.
(Note 2) The values shown are payload capacities during operation at maximum speed.
(Note 3) For a 10,000-km running life.
(Note 4) The maximum cable length is 30 m. Please specify length in meters.
(E.g., X08 = 8 m)
(Note 5) When an axis with a long stroke (1,300 mm or more) is used hanging from the ceiling, the cover of the body may hang down and contact the slider. Therefore, in cases of such use, please contact our sales representative in advance.

NS-MXMXS

Single-Axis Robot Medium Nut Rotation Type Main Unit Width 125mm 200W
Horizontal Type With Mid-Support Single Slider



Model **NS — MXMXS —** **200** — — — **T2** — — **AQ** — — **RT**

Series Type Encoder Type Motor Type Lead Stroke Applicable controller Cable Length Option
 A: Absolute Motor Type 200: 200W 30: 30mm 1600: 1,600mm T2: SCON N: No
 I: Incremental 20: 20mm 2200: 2,200mm SSEL S: 3m
 XSEL-P/Q M: 5m
 X□□: Length Specified
 See the options table below

Model/Specification

Model	Encoder Type	Motor Output (W)	Lead (mm)	Stroke (mm)	Speed (mm/s)	Acceleration (Note 1)				Payload capacity (Note 1 & 2)				Rated Thrust (N)
						Horizontal (G)		Vertical (G)		Horizontal (kg)		Vertical (kg)		
						Rated	Maximum	Rated	Maximum	Rated Acceleration	Maximum Acceleration	Rated Acceleration	Maximum Acceleration	
NS-MXMXS- <input type="checkbox"/> -200-30- <input type="checkbox"/> -T2- <input type="checkbox"/> -AQ- <input type="checkbox"/> -RT	Absolute	200	30	1600-2200	1800	0.3	Horizontal Only	25	Horizontal Only	113.9				
														Incremental

*In the model above, indicates the type of encoder, indicates the stroke, indicates the cable length, and indicates the option.

Option

Name	Model	Reference page	Note
AQ Seal	AQ	→P5	Standard Equipment
Installation Direction of Standard Cable Track	CT1~CT4	→P5	Enter CT1 for standard installation
Guide with Ball-Retaining Mechanism	RT	→P6	Standard Equipment

Common specifications

Driving Method	Ball Thread, Diameter $\phi 16$ mm, Equivalent to Rolled C5
Repeated Positioning Accuracy	+/- 0.01 mm
Backlash	0.02 mm or less
Guide	Integrated to Base
Dynamic Allowable Moment (Note 3)	Ma: 69.6N·m, Mb: 99.0N·m, Mc: 161.7N·m
Overhung load length	Ma Direction: 600mm or less; Mb and Mc Direction: 600mm or less
Base	Material: Aluminium, White Alumite Treatment
Cable Length (Note 4)	N: No cable; S: 3 m; M: 5 m; X□□: Length specified
Ambient Temperature	0~40 degrees Celsius, 85% RH or less (No condensation)

Dimensional drawing

The CAD drawings can be downloaded from our homepage.

2D CAD

*1 Connects motor cables and encoder cables.
For details on cables, please see page 22.

SE: Stroke End
ME: Mechanical End

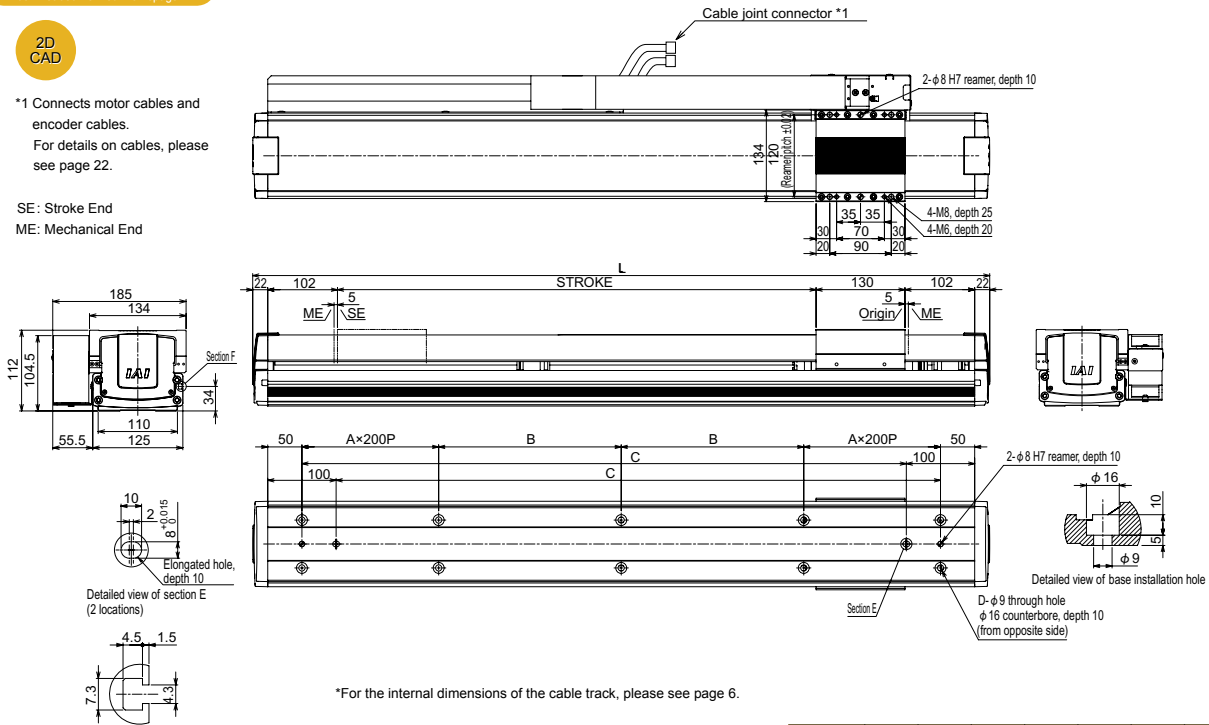

*For the internal dimensions of the cable track, please see page 6.

Detailed view of section F (T-slot in base)

Note: Due to their structure, models with a mid-support cannot be positioned horizontally on their side or vertically.

Stroke	1600	1700	1800	1900	2000	2100	2200
L	1978	2078	2178	2278	2378	2478	2578
A	3	4	4	4	4	5	5
B	317	167	217	267	317	167	217
C	1784	1884	1984	2084	2184	2284	2384
D	18	22	22	22	22	26	26
Mass (kg)	26.2	27.5	28.7	29.9	31.2	32.4	33.6

Applicable Controller Specifications

Applicable Controller	Max. Number of Axes Controlled	Compatible Encoder Type	Operation Method	Power/Voltage
X-SEL-P/Q	6 axis	Absolute/Incremental	Programs	Three-Phase/Single-Phase 200VAC
SSEL	2 axis			Single-Phase
SCON	1 axis		Positioner Pulse Train Control	100/200VAC



Note

(Note 1) The maximum acceleration is 0.3 G.
 (Note 2) The values shown are payload capacities during operation at maximum speed.
 (Note 3) For a 10,000-km running life.
 (Note 4) The maximum cable length is 30 m. Please specify length in meters. (E.g., X08 = 8 m)
 (Note 5) When an axis with a long stroke (1,300 mm or more) is used hanging from the ceiling, the cover of the body may hang down and contact the slider. Therefore, in cases of such use, please contact our sales representative in advance.

NS-MZMS

Single-Axis Robot Medium Nut Rotation Type Main Unit Width 125mm 200W
Vertical Type Single Slider

Model **NS — MZMS — [] — 200 — [] — [] — T2 — [] — AQ — B [] — RT**

Series	Type	Encoder Type	Motor Type	Lead	Stroke	Applicable controller	Cable Length
A: Absolute I: Incremental	200: 200W 20: 20 mm	500: 500mm 800: 800mm	T2: SCON SSEL XSEL-P/Q	N: No S: 3m M: 5m X: Length Specified	See the options table below		



Model/Specification

Model	Encoder Type	Motor Output (W)	Lead (mm)	Stroke (mm)	Speed (mm/s)	Acceleration (Note 1)				Payload capacity (Note 1 & 2)				Rated Thrust (N)
						Horizontal (G)		Vertical (G)		Horizontal (kg)		Vertical (kg)		
						Rated	Maximum	Rated	Maximum	Rated Acceleration	Maximum Acceleration	Rated Acceleration	Maximum Acceleration	
NS-MZMS-①-200-20-②-T2-③-AQ-④-RT	Absolute Incremental	200	20	500-800	1000	Vertical Only	0.3	0.5	Vertical Only	6	3	170.9		

*In the model above, ① indicates the type of encoder, ② indicates the stroke, ③ indicates the cable length, and ④ indicates the option.

Option

Name	Model	Reference page	Note
AQ Seal	AQ	→P5	Standard Equipment
Brake (*)	B	→P5	Standard Equipment
Installation Direction of Standard Cable Track	CT1-CT4	→P5	Enter CT1 for standard installation
Guide with Ball-Retaining Mechanism	RT	→P6	Standard Equipment

(*) A brake box is attached for powering the brake.
(For details, see page 21)

Common specifications

Driving Method	Ball Thread, Diameter $\phi 16$ mm, Equivalent to Rolled C5
Repeated Positioning Accuracy	± 0.01 mm
Backlash	0.02 mm or less
Guide	Integrated to Base
Dynamic Allowable Moment (Note 3)	Ma: 69.6N·m, Mb: 99.0N·m, Mc: 81.3N·m
Overhung load length	Ma Direction: 600mm or less; Mb and Mc Direction: 600mm or less
Base	Material: Aluminium, White Alumite Treatment
Cable Length (Note 4)	N: No cable; S: 3 m; M: 5 m; X: Length specified
Ambient Temperature	0-40 degrees Celsius, 85% RH or less (No condensation)

Dimensional drawing

The CAD drawings can be downloaded from our homepage.

2D CAD

*1 Connects motor cables and encoder cables.
For details on cables, please see page 22.

SE: Stroke End
ME: Mechanical End

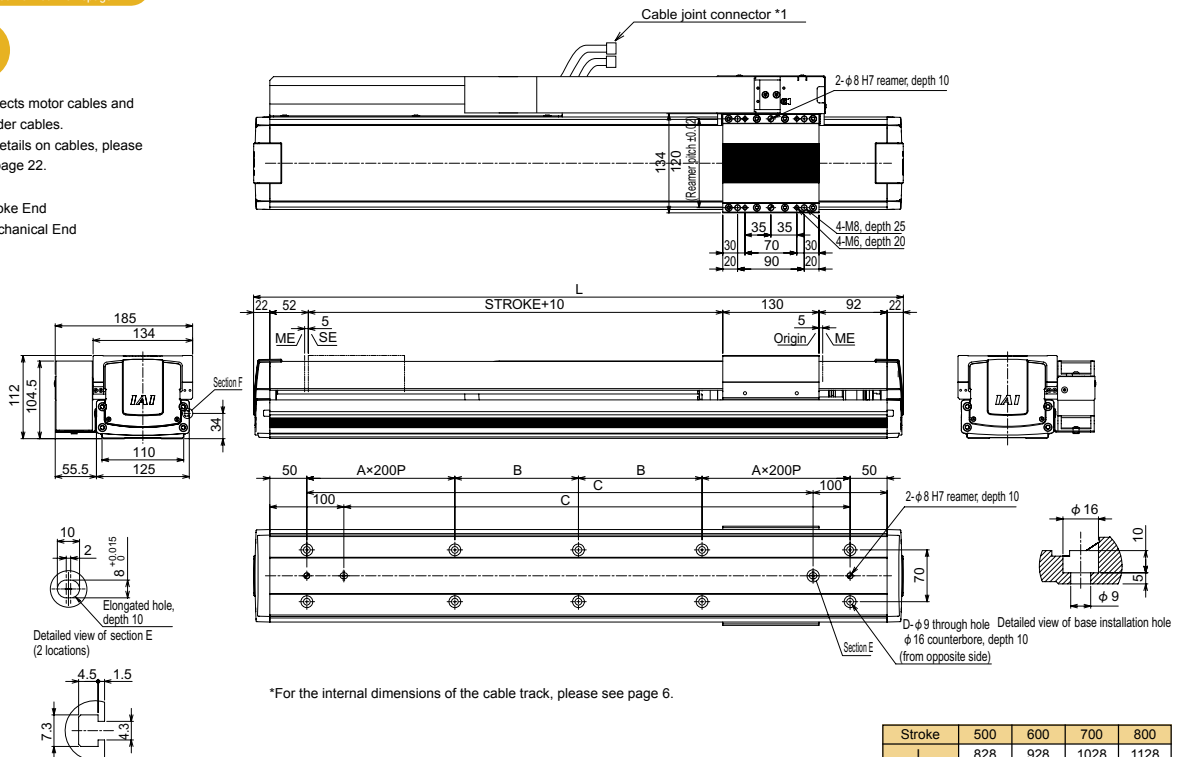

*For the internal dimensions of the cable track, please see page 6.

Detailed view of section F (T-slot in base)

Stroke	500	600	700	800
L	828	928	1028	1128
A	1	1	1	1
B	142	192	242	292
C	634	734	834	934
D	10	10	10	10
Mass (kg)	13.5	14.8	16.0	17.2

Applicable Controller Specifications

Applicable Controller	Max. Number of Axes Controlled	Compatible Encoder Type	Operation Method	Power/Voltage
X-SEL-P/Q	6 axis	Absolute/Incremental	Programs	Three-Phase/Single-Phase 200VAC
SSEL	2 axis		Positioner Pulse Train Control	Single-Phase 100/200VAC
SCON	1 axis			



Note

(Note 1) For the relationship between acceleration and payload capacity, see page 4.
(Note 2) The values shown are payload capacities during operation at maximum speed.
(Note 3) For a 10,000-km running life.
(Note 4) The maximum cable length is 30 m. Please specify length in meters.
(E.g., X08 = 8 m)

NS-MZMM

Single-Axis Robot Medium Nut Rotation Type Main Unit Width 125mm 200W
Vertical Type Multi-Slider



■Model **NS — MZMM — [] — 200 — [] — [] — T2 — [] — AQ — B — CT1 — RT**

Series Type Encoder Type Motor Type Lead Stroke Applicable controller Cable Length

A: Absolute 200: 200W 20: 20 mm 300: 300mm T2: SCON N: No SSEL S: 3m See the options table below

I: Incremental 800: 800mm XSEL-P/Q M: 5m X□□: Length Specified

Model/Specification

Model	Encoder Type	Motor Output (W)	Lead (mm)	Stroke (mm)	Speed (mm/s)	Acceleration (Note 1)				Payload capacity (Note 1 & 2)				Rated Thrust (N)
						Horizontal (G)		Vertical (G)		Horizontal (kg)		Vertical (kg)		
						Rated	Maximum	Rated	Maximum	Rated Acceleration	Maximum Acceleration	Rated Acceleration	Maximum Acceleration	
NS-MZMM-①-200-20-②-T2-③-AQ-④-RT	Absolute Incremental	200	20	300~800	1000	Vertical Only	0.3	0.5	Vertical Only	6	3	170.9		

*In the model above, ① indicates the type of encoder, ② indicates the stroke, ③ indicates the cable length, and ④ indicates the option.

Option

Name	Model	Reference page	Note
AQ Seal	AQ	→P5	Standard Equipment
Brake (*)	B	→P5	Standard Equipment
Installation Direction of Standard Cable Track	CT1	→P5	CT1 for standard
Guide with Ball-Retaining Mechanism	RT	→P6	Standard Equipment

(*) A brake box is attached for powering the brake.
(For details, see page 21)

Common specifications

Driving Method	Ball Thread, Diameter $\phi 16$ mm, Equivalent to Rolled C5
Repeated Positioning Accuracy	± 0.01 mm
Backlash	0.02 mm or less
Guide	Integrated to Base
Dynamic Allowable Moment (Note 3)	Ma: 69.6N·m, Mb: 99.0N·m, Mc: 81.3N·m
Overhung load length	Ma Direction: 600mm or less; Mb and Mc Direction: 600mm or less
Base	Material: Aluminium, White Alumite Treatment
Cable Length (Note 4)	N: No cable; S: 3 m; M: 5 m; X□□: Length specified
Ambient Temperature	0~40 degrees Celsius, 85% RH or less (No condensation)

Dimensional drawing

The CAD drawings can be downloaded from our homepage.

2D CAD

*1 Connects motor cables and encoder cables.
For details on cables, please see page 22.

SE: Stroke End
ME: Mechanical End

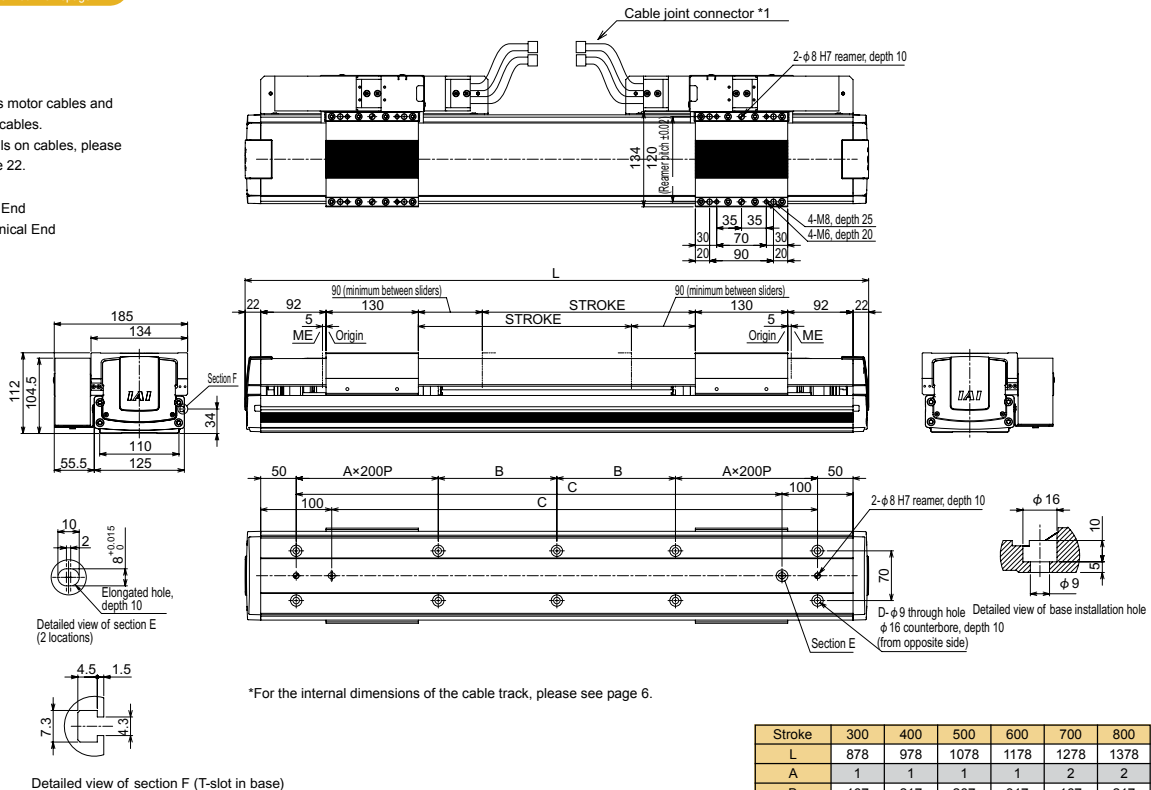

*For the internal dimensions of the cable track, please see page 6.

Stroke	300	400	500	600	700	800
L	878	978	1078	1178	1278	1378
A	1	1	1	1	2	2
B	167	217	267	317	167	217
C	684	784	884	984	1084	1184
D	10	10	10	10	14	14
Mass (kg)	17.2	18.4	19.7	20.9	22.1	23.4

Applicable Controller Specifications

Applicable Controller	Max. Number of Axes Controlled	Compatible Encoder Type	Operation Method	Power/Voltage
X-SEL-P/Q	6 axis	Absolute/Incremental	Programs Positioner/Pulse Train Control	Three-Phase/Single-Phase 200VAC
SSEL	2 axis			Single-Phase 100/200VAC
SCON	1 axis			

Note: A two-axis controller is required to operate the multi-slider.
Two controllers are required for SCON.
(Please note that SCON does not have a collision prevention mechanism)



Note

(Note 1) For the relationship between acceleration and payload capacity, see page 4.
(Note 2) The values shown are payload capacities during operation at maximum speed.
(Note 3) For a 10,000-km running life.
(Note 4) The maximum cable length is 30 m. Please specify length in meters.
(E.g., X08 = 8 m)

NS-LXMS

Single-Axis Robot Large Nut Rotation Type Main Unit Width 145mm 400W
Horizontal Type Single Slider



Model: NS - LXMS - [] - 400 - [] - [] - T2 - [] - AQ - [] - RT

Series	Type	Encoder Type	Motor Type	Lead	Stroke	Applicable controller	Cable Length	Option
A: Absolute I: Incremental	400: 400W	40: 40mm 20: 20 mm	500: 500mm T2: SCON SSEL XSEL-P/Q	2200: 2,200mm	N: No S: 3m M: 5m X□□: Length Specified	See the options table below		

Model/Specification

Model	Encoder Type	Motor Output (W)	Lead (mm)	Stroke (mm)	Speed (mm/s)	Acceleration (Note 1)				Payload capacity (Note 1 & 2)				Rated Thrust (N)
						Horizontal (G)		Vertical (G)		Horizontal (kg)		Vertical (kg)		
						Rated	Maximum	Rated	Maximum	Rated	Maximum	Rated	Maximum	
NS-LXMS-□-400-40-□-T2-□-AQ-□-RT	Absolute	400	40	500~2200	2400	0.3	1.0	Horizontal Only		40	10	Horizontal Only		170
NS-LXMS-□-400-20-□-T2-□-AQ-□-RT	Incremental		20		1300	0.3	1.0			80	24			340.1

*In the model above, □ indicates the type of encoder, □ indicates the stroke, □ indicates the cable length, and □ indicates the option.

Option

Name	Model	Reference page	Note
AQ Seal	AQ	→P5	Standard Equipment
Creep Sensor	C	→P5	
Installation Direction of Standard Cable Track	CT1~CT4	→P5	Enter CT1 for standard installation
Installation Direction of Extended Cable Track	ET1~ET4	→P5	
Limit Switch	L	→P6	
Guide with Ball-Retaining Mechanism	RT	→P6	Standard Equipment

Common specifications

Driving Method	Ball Thread, Diameter φ20 mm, Equivalent to Rolled C5
Repeated Positioning Accuracy	+/- 0.01 mm
Backlash	0.02 mm or less
Guide	Integrated to Base
Dynamic Allowable Moment (Note 3)	Ma: 104.9N·m, Mb: 149.9N·m, Mc: 248.9N·m
Overhung load length	Ma Direction: 750 mm or less; Mb and Mc Direction: 750 mm or less
Base	Material: Aluminium, White Alumite Treatment
Cable Length (Note 4)	N: No cable; S: 3 m; M: 5 m; X□□: Length specified
Ambient Temperature	0~40 degrees Celsius, 85% RH or less (No condensation)

Dimensional drawing

The CAD drawings can be downloaded from our homepage.



*1 Connects motor cables and encoder cables.
For details on cables, please see page 22.

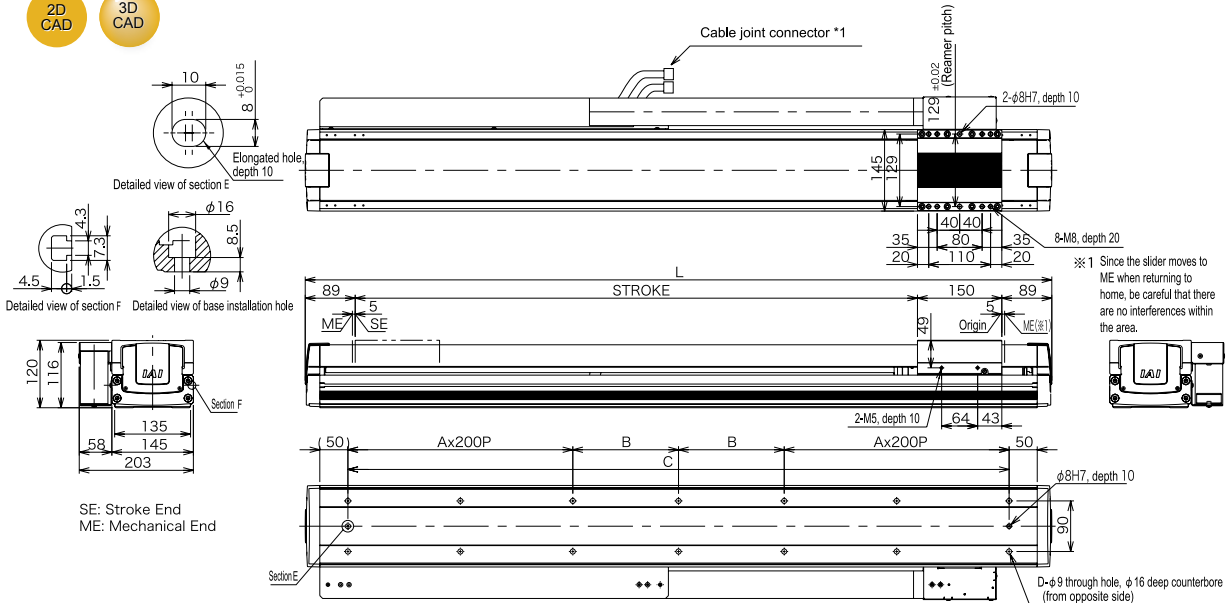

*For the internal dimensions of the cable track, please see page 6.

Stroke	500	600	700	800	900	1000	1100	1200	1300	1400	1500	1600	1700	1800	1900	2000	2100	2200	
L	828	928	1028	1128	1228	1328	1428	1528	1628	1728	1828	1928	2028	2128	2228	2328	2428	2528	
A	1	1	1	1	2	2	2	2	3	3	3	3	3	4	4	4	4	5	5
B	138	188	238	288	338	388	438	488	538	588	638	688	738	788	838	888	938	988	1038
C	676	776	876	976	1076	1176	1276	1376	1476	1576	1676	1776	1876	1976	2076	2176	2276	2376	
D	10	10	10	10	14	14	14	14	18	18	18	18	22	22	22	22	26	26	
Mass (kg)	18.6	20.1	21.6	23.1	24.5	26.0	27.5	29.0	30.5	32.0	33.5	35.0	36.5	38.0	39.5	41.0	42.5	43.9	

Applicable Controller Specifications

Applicable Controller	Max. Number of Axes Controlled	Compatible Encoder Type	Operation Method	Power/Voltage
X-SEL-P/Q	6 axis	Absolute/ Incremental	Programs	Three-Phase/ Single-Phase 200VAC
SSEL	2 axis		Positioner/Pulse Train Control	Single-Phase 100/200VAC
SCON	1 axis			



Note

(Note 1) For the relationship between acceleration and payload capacity, see page 4.
 (Note 2) The values shown are payload capacities during operation at maximum speed.
 (Note 3) For a 10,000-km running life.
 (Note 4) The maximum cable length is 30 m. Please specify length in meters.
 (E.g., X08 = 8 m)
 (Note 5) When an axis with a long stroke (1,300 mm or more) is used hanging from the ceiling, the cover of the body may hang down and contact the slider. Therefore, in cases of such use, please contact our sales representative in advance.

NS-LXMM

Single-Axis Robot Large Nut Rotation Type Main Unit Width 145mm 400W
Horizontal Type Multi-Slider



Model: **NS-LXMM** - [] - **400** - [] - [] - **T2** - [] - **AQ** - [] - **RT**

Series	Type	Encoder Type	Motor Type	Lead	Stroke	Applicable controller	Cable Length	Option
A: Absolute I: Incremental	400: 400W	40: 40mm 20: 20 mm	250: 250mm 2250: 2,250mm	T2: SCON SSEL XSEL-P/Q	N: No S: 3m M: 5m X: Length Specified			See the options table below

Model/Specification

Model	Encoder Type	Motor Output (W)	Lead (mm)	Stroke (mm)	Speed (mm/s)	Acceleration (Note 1)				Payload capacity (Note 1 & 2)				Rated Thrust (N)
						Horizontal (G)		Vertical (G)		Horizontal (kg)		Vertical (kg)		
						Rated	Maximum	Rated	Maximum	Rated	Maximum	Rated	Maximum	
NS-LXMM-①-400-②-T2-③-AQ-④-RT	Absolute	400	40	250-2250	2400	0.3	1.0	Horizontal Only		40	10	Horizontal Only		170
NS-LXMM-①-400-②-T2-③-AQ-④-RT	Incremental		20		1300	0.3	1.0			80	24			340.1

*In the model above, ① indicates the type of encoder, ② indicates the stroke, ③ indicates the cable length, and ④ indicates the option.

Option

Name	Model	Reference page	Note
AQ Seal	AQ	→P5	Standard Equipment
Creep Sensor	C	→P5	
Standard/Extended Cable Track Selection	CT1/ET1	→P5	Enter CT1 for Standard Cable Track
Limit Switch	L	→P6	
Guide with Ball-Retaining Mechanism	RT	→P6	Standard Equipment

Common specifications

Driving Method	Ball Thread, Diameter $\phi 20$ mm, Equivalent to Rolled C5
Repeated Positioning Accuracy	± 0.01 mm
Backlash	0.02 mm or less
Guide	Integrated to Base
Dynamic Allowable Moment (Note 3)	Ma: 104.9N·m, Mb: 149.9N·m, Mc: 248.9N·m
Overhung load length	Ma Direction: 750 mm or less; Mb and Mc Direction: 750 mm or less
Base	Material: Aluminium, White Alumite Treatment
Cable Length (Note 4)	N: No cable; S: 3 m; M: 5 m; X: Length specified
Ambient Temperature	0-40 degrees Celsius, 85% RH or less (No condensation)

Dimensional drawing

The CAD drawings can be downloaded from our homepage.



*1 Connects motor cables and encoder cables.
For details on cables, please see page 22.

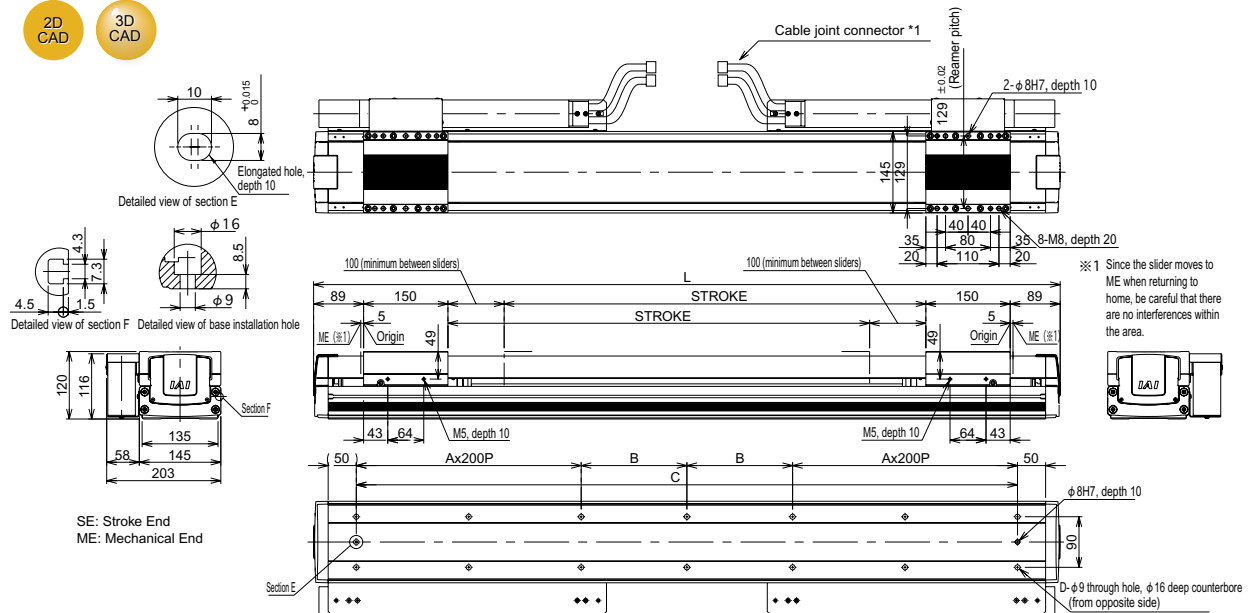

*For the internal dimensions of the cable track, please see page 6.

Stroke	250	350	450	550	650	750	850	950	1050	1150	1250	1350	1450	1550	1650	1750	1850	1950	2050	2150	2250
L	828	928	1028	1128	1228	1328	1428	1528	1628	1728	1828	1928	2028	2128	2228	2328	2428	2528	2628	2728	2828
A	1	1	1	1	2	2	2	2	3	3	3	3	4	4	4	4	5	5	5	5	6
B	138	188	238	288	138	188	238	288	138	188	238	288	138	188	238	288	138	188	238	288	138
C	676	776	876	976	1076	1176	1276	1376	1476	1576	1676	1776	1876	1976	2076	2176	2276	2376	2476	2576	2676
D	10	10	10	10	14	14	14	14	18	18	18	18	22	22	22	22	26	26	26	26	30
Mass (kg)	24.7	26.4	28.2	29.9	31.6	33.4	35.1	36.8	38.6	40.3	42	43.8	45.5	47.2	48.9	50.7	52.4	54.1	55.9	57.6	59.3

Applicable Controller Specifications

Applicable Controller	Max. Number of Axes Controlled	Compatible Encoder Type	Operation Method	Power/Voltage
X-SEL-P/Q	6 axis	Absolute/ Incremental	Programs Positioner/Pulse Train Control	Three-Phase/ Single-Phase 200VAC
SSEL	2 axis			Single-Phase 100/200VAC
SCON	1 axis			

Note: A two-axis controller is required to operate the multi-slider.
Two controllers are required for SCON.
(Please note that SCON does not have a collision prevention mechanism)



Note

(Note 1) For the relationship between acceleration and payload capacity, see page 4.
(Note 2) The values shown are payload capacities during operation at maximum speed.
(Note 3) For a 10,000-km running life.
(Note 4) The maximum cable length is 30 m. Please specify length in meters.
(E.g., X08 = 8 m)
(Note 5) When an axis with a long stroke (1,300 mm or more) is used hanging from the ceiling, the cover of the body may hang down and contact the slider. Therefore, in cases of such use, please contact our sales representative in advance.

NS-LXMXS Single-Axis Robot Large Nut Rotation Type Main Unit Width 145mm 400W Horizontal Type With Mid-Support Single Slider

Model: NS-LXMXS-□-400-□-□-T2-□-AQ-□-RT

Series	Type	Encoder Type	Motor Type	Lead	Stroke	Applicable controller	Cable Length	Option
A: Absolute I: Incremental	400: 400W	40: 40mm 20: 20 mm	2300: 2,300mm 3000: 3,000mm	T2: SCON SSEL XSEL-P/Q	N: No S: 3m M: 5m X□□: Length Specified		See the options table below	



Model/Specification

Model	Encoder Type	Motor Output (W)	Lead (mm)	Stroke (mm)	Speed (mm/s)	Acceleration (Note 1)				Payload capacity (Note 1 & 2)				Rated Thrust (N)
						Horizontal (G)		Vertical (G)		Horizontal (kg)		Vertical (kg)		
						Rated	Maximum	Rated	Maximum	Rated Acceleration	Maximum Acceleration	Rated Acceleration	Maximum Acceleration	
NS-LXMXS-①-400-②-③-T2-④-AQ-⑤-RT	Absolute	400	40	2300-3000	2400	0.3	Horizontal Only		40	Horizontal Only		170		
NS-LXMXS-①-400-②-③-T2-④-AQ-⑤-RT	Incremental		20		1300	0.3			80			340.1		

*In the model above, ① indicates the type of encoder, ② indicates the stroke, ③ indicates the cable length, and ④ indicates the option.

Option

Name	Model	Reference page	Note
AQ Seal	AQ	→P5	Standard Equipment
Creep Sensor	C	→P5	
Installation Direction of Standard Cable Track	CT1-CT4	→P5	Enter CT1 for standard installation
Installation Direction of Extended Cable Track	ET1-ET4	→P5	
Limit Switch	L	→P6	
Guide with Ball-Retaining Mechanism	RT	→P6	Standard Equipment

Common specifications

Driving Method	Ball Thread, Diameter φ20 mm, Equivalent to Rolled C5
Repeated Positioning Accuracy	±0.01mm
Backlash	0.02 mm or less
Guide	Integrated to Base
Dynamic Allowable Moment (Note 3)	Ma: 104.9N·m, Mb: 149.9N·m, Mc: 248.9N·m
Overhung load length	Ma Direction: 750 mm or less; Mb and Mc Direction: 750 mm or less
Base	Material: Aluminium, White Alumite Treatment
Cable Length (Note 4)	N: No cable; S: 3 m; M: 5 m; X□□: Length specified
Ambient Temperature	0-40 degrees Celsius, 85% RH or less (No condensation)

Dimensional drawing

The CAD drawings can be downloaded from our homepage.

*1 Connects motor cables and encoder cables. For details on cables, please see page 22.

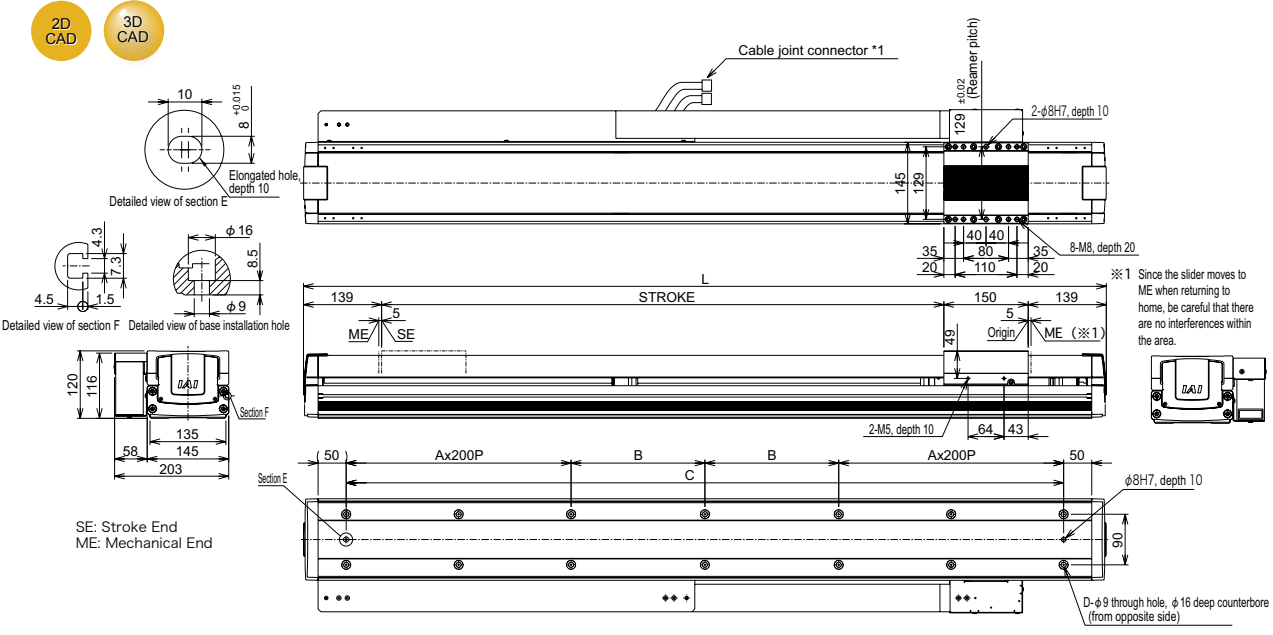

Note: Due to their structure, models with a mid-support cannot be positioned horizontally on their side or vertically.

*For the internal dimensions of the cable track, please see page 6.

Stroke	2300	2400	2500	2600	2700	2800	2900	3000
L	2728	2828	2928	3028	3128	3228	3328	3428
A	5	6	6	6	6	7	7	7
B	288	138	188	238	288	138	188	238
C	2576	2676	2776	2876	2976	3076	3176	3276
D	26	30	30	30	30	34	34	34
Mass (kg)	46.4	47.9	49.4	50.9	52.3	53.8	55.3	56.8

Applicable Controller Specifications

Applicable Controller	Max. Number of Axes Controlled	Compatible Encoder Type	Operation Method	Power/Voltage
X-SEL-P/Q	6 axis	Absolute/ Incremental	Programs Positioner Pulse Train Control	Three-Phase/ Single-Phase 200VAC
SSEL	2 axis			Single-Phase 100/200VAC
SCON	1 axis			

Note

(Note 1) The maximum acceleration is 0.3 G.
 (Note 2) The values shown are payload capacities during operation at maximum speed.
 (Note 3) For a 10,000-km running life.
 (Note 4) The maximum cable length is 30 m. Please specify length in meters. (E.g., X08 = 8 m)
 (Note 5) When an axis with a long stroke (1,300 mm or more) is used hanging from the ceiling, the cover of the body may hang down and contact the slider. Therefore, in cases of such use, please contact our sales representative in advance.

NS-LZMS

Single-Axis Robot Large Nut Rotation Type Main Unit Width 145mm 400W
Vertical Type Single Slider



Model: NS-LZMS-□-400-□-□-T2-□-AQ-B-□-RT

Series	Type	Encoder Type	Motor Type	Lead	Stroke	Applicable controller	Cable Length	Option
NS	LZMS	A: Absolute I: Incremental	400: 400W	20: 20 mm	500: 500mm 1000: 1,000mm	T2: SCON SSEL XSEL-P/Q	N: No S: 3m M: 5m X□: Length Specified	See the options table below

Model/Specification

Model	Encoder Type	Motor Output (W)	Lead (mm)	Stroke (mm)	Speed (mm/s)	Acceleration (Note 1)				Payload capacity (Note 1 & 2)				Rated Thrust (N)
						Horizontal (G)		Vertical (G)		Horizontal (kg)		Vertical (kg)		
						Rated	Maximum	Rated	Maximum	Rated Acceleration	Maximum Acceleration	Rated Acceleration	Maximum Acceleration	
NS-LZMS-①-400-20-②-T2-③-AQ-B-④-RT	Absolute Incremental	400	20	500~1000	1000	Vertical Only	0.3	0.8	Vertical Only	16	6.0	340.1		

*1 In the model above, ① indicates the type of encoder, ② indicates the stroke, ③ indicates the cable length, and ④ indicates the option.

Option

Name	Model	Reference page	Note
AQ Seal	AQ	→P5	Standard Equipment
Brake (*)	B	→P5	Standard Equipment
Creep Sensor	C	→P5	
Installation Direction of Standard Cable Track	CT1~CT4	→P5	Enter CT1 for standard installation
Installation Direction of Extended Cable Track	ET1~ET4	→P5	
Limit Switch	L	→P6	
Guide with Ball-Retaining Mechanism	RT	→P6	Standard Equipment

(*) A brake box is attached for powering the brake. (For details, see page 21)

Common specifications

Driving Method	Ball Thread, Diameter $\phi 20$ mm, Equivalent to Rolled C5
Repeated Positioning Accuracy	± 0.01 mm
Backlash	0.02 mm or less
Guide	Integrated to Base
Dynamic Allowable Moment (Note 3)	Ma: 104.9N·m; Mb: 149.9N·m; Mc: 248.9N·m
Overhung load length	Ma Direction: 750 mm or less; Mb and Mc Direction: 750 mm or less
Brake	Non-excitation electromagnetic brakes are installed as standard equipment
Base	Material: Aluminium, White Alumite Treatment
Cable Length (Note 4)	N: No cable; S: 3 m; M: 5 m; X□: Length specified
Ambient Temperature	0~40 degrees Celsius, 85% RH or less (No condensation)

Dimensional drawing

The CAD drawings can be downloaded from our homepage.



*1 Connects motor cables and encoder cables. For details on cables, please see page 22.

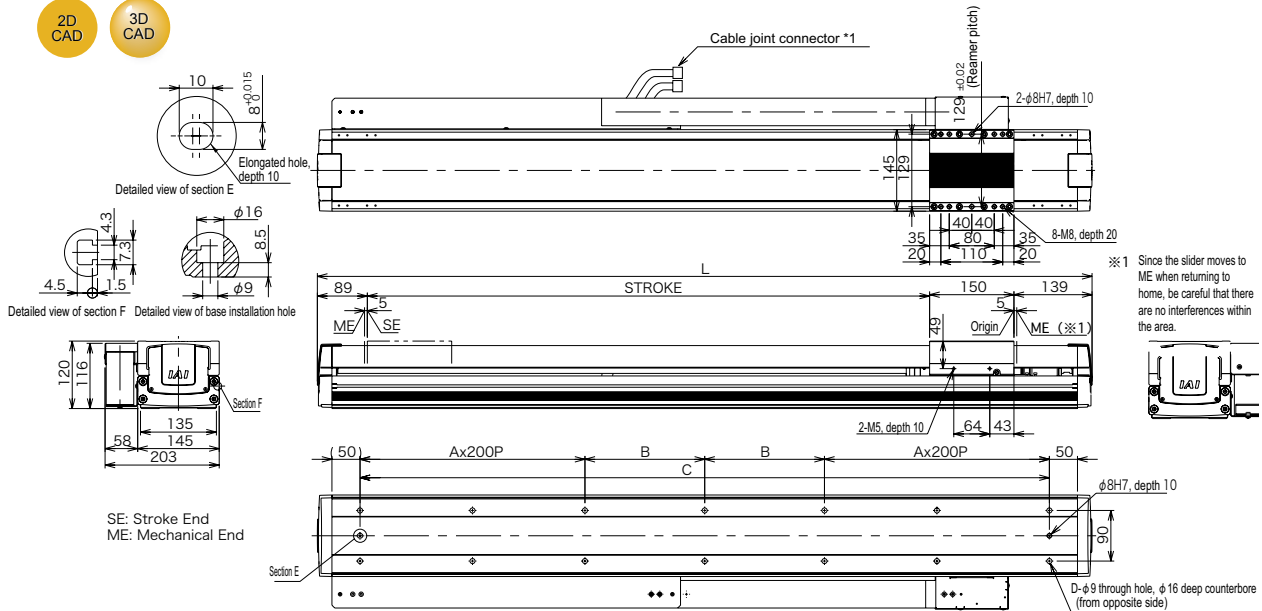

*For the internal dimensions of the cable track, please see page 6.

Stroke	500	600	700	800	900	1000
L	878	978	1078	1178	1278	1378
A	1	1	1	2	2	2
B	163	213	263	113	163	213
C	726	826	926	1026	1126	1226
D	10	10	10	14	14	14
Mass (kg)	19.9	21.4	22.9	24.4	25.9	27.4

Applicable Controller Specifications

Applicable Controller	Max. Number of Axes Controlled	Compatible Encoder Type	Operation Method	Power/Voltage
X-SEL-P/Q	6 axis	Absolute/ Incremental	Programs	Three-Phase/ Single-Phase 200VAC
SSEL	2 axis		Positioner Pulse Train Control	Single-Phase 100/200VAC
SCON	1 axis			



Note

(Note 1) For the relationship between acceleration and payload capacity, see page 4.
(Note 2) The values shown are payload capacities during operation at maximum speed.
(Note 3) For a 10,000-km running life.
(Note 4) The maximum cable length is 30 m. Please specify length in meters. (E.g., X08 = 8 m)

NS-LZMM

Single-Axis Robot Large Nut Rotation Type Main Unit Width 145mm 400W
Vertical Type Multi-Slider



Model **NS-LZMM-400-T2-AQ-B-RT**

Series	Type	Encoder Type	Motor Type	Lead	Stroke	Applicable controller	Cable Length
A: Absolute I: Incremental	400: 400W	20: 20 mm	250: 250mm	T2: SCON	N: No S: 3m M: 5m X□□: Length Specified		

See the options table below

Model/Specification

Model	Encoder Type	Motor Output (W)	Lead (mm)	Stroke (mm)	Speed (mm/s)	Acceleration (Note 1)				Payload capacity (Note 1 & 2)				Rated Thrust (N)
						Horizontal (G)		Vertical (G)		Horizontal (kg)		Vertical (kg)		
						Rated	Maximum	Rated	Maximum	Rated Acceleration	Maximum Acceleration	Rated Acceleration	Maximum Acceleration	
NS-LZMM-400-20-T2-AQ-B-RT	Absolute Incremental	400	20	250-950	1000	Vertical Only	0.3	0.8	Vertical Only	16	6.0	340.1		

*In the model above, ① indicates the type of encoder, ② indicates the stroke, ③ indicates the cable length, and ④ indicates the option.

Option

Name	Model	Reference page	Note
AQ Seal	AQ	→P5	Standard Equipment
Brake (*)	B	→P5	Standard Equipment
Creep Sensor	C	→P5	
Standard/Extended Cable Track Selection	CT1/ET1	→P5	Enter CT1 for Standard Cable Track
Limit Switch	L	→P6	
Guide with Ball-Retaining Mechanism	RT	→P6	Standard Equipment

(*) A brake box is attached for powering the brake.
(For details, see page 21)

Common specifications

Driving Method	Ball Thread, Diameter φ20 mm, Equivalent to Rolled C5
Repeated Positioning Accuracy	±0.01mm
Backlash	0.02 mm or less
Guide	Integrated to Base
Dynamic Allowable Moment (Note 3)	Ma: 104.9N·m; Mb: 149.9N·m; Mc: 248.9N·m
Overhung load length	Ma Direction: 750 mm or less; Mb and Mc Direction: 750 mm or less
Brake	Non-excitation electromagnetic brakes are installed as standard equipment
Base	Material: Aluminium, White Alumite Treatment
Cable Length (Note 4)	N: No cable; S: 3 m; M: 5 m; X□□: Length specified
Ambient Temperature	0~40 degrees Celsius, 85% RH or less (No condensation)

Dimensional drawing

The CAD drawings can be downloaded from our homepage.

*1 Connects motor cables and encoder cables.
For details on cables, please see page 22.

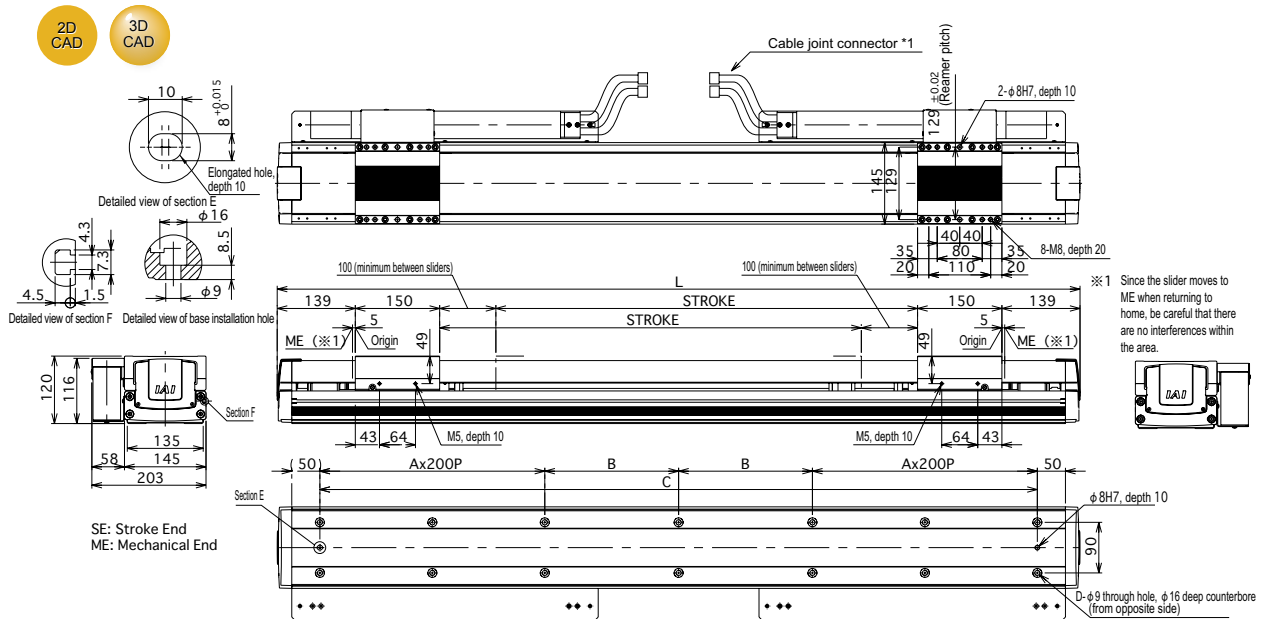

*For the internal dimensions of the cable track, please see page 6.

Stroke	250	350	450	550	650	750	850	950
L	928	1028	1128	1228	1328	1428	1528	1628
A	1	1	1	2	2	2	2	3
B	188	238	288	338	388	438	488	538
C	776	876	976	1076	1176	1276	1376	1476
D	10	10	10	14	14	14	14	18
Mass (kg)	27.1	28.8	30.5	32.2	34	35.7	37.4	39.2

Applicable Controller Specifications

Applicable Controller	Max. Number of Axes Controlled	Compatible Encoder Type	Operation Method	Power/Voltage
X-SEL-P/Q	6 axis	Absolute/ Incremental	Programs Positioner Pulse Train Control	Three-Phase/ Single-Phase 200VAC
SSEL	2 axis			Single-Phase 100/200VAC
SCON	1 axis			





Note: A two-axis controller is required to operate the multi-slider.
Two controllers are required for SCON.
(Please note that SCON does not have a collision prevention mechanism)



Note

(Note 1) For the relationship between acceleration and payload capacity, see page 4.
(Note 2) The values shown are payload capacities during operation at maximum speed.
(Note 3) For a 10,000-km running life.
(Note 4) The maximum cable length is 30 m. Please specify length in meters.
(E.g., X08 = 8 m)

Controller

	Controller Series/Type	SCON	SSEL	XSEL		
				P (Standard) Type	Q (Global) Type	
Basic Specifications	Form					
	Power Capacity	Maximum: 844VA	Maximum: 1660VA (For 400W 2-axis operation)	Maximum: 4988VA (For 6-axis operation total of 2400W)		
	Input Power	Single-Phase AC 200V	Single-Phase AC 100V Single-Phase AC 200V	Three-Phase AC 200V Single-Phase AC 200V		
	Range of Operating Power Voltages	±10%				
Control Specifications	Maximum total connected axes output (W)	750W(for 200V power supply)	400W(for 100V power supply) 800W(for 200V power supply)	2,400W(For three-phase) 1,600W(For single-phase)		
	Max. Number of Axes Controlled	1 axis	2 axis	6 axis		
	Position Detection Method	Incremental Encoder/Absolute Encoder				
	Safety Circuit Configuration	Duplexing not possible		Duplexing not possible	Duplexing possible	
	Operation Method	Positioner Operation Pulse Train Control	Program Operation Positioner Operation (Switchable)	Program Operation Only		
Programs	Number of Programs	—	—	128		
	Number of Program Steps	—	—	9999		
	Number of Multi-Task Programs	—	8	16		
	Number of Positions	Maximum: 512	—	20000		
	Data Input Device (Optional)	Teaching Box Model: CON-T/RCM-E PC-Supported Soft ware Model: RCM-101-MW (For RS232 Communication) RCM-101-USB (For USB Communication)	Teaching Box Model: SEL-T-J/SEL-TD-J PC-Supported Soft ware Model: IA-101-X-MW-J (For RS232 Communication) IA-101-X-USB (For USB Communication)	Teaching Box Model: SEL-T/SEL-TD PC-Supported Soft ware Model: IA-101-X-MW (For RS232 Communication) IA-101-X-USBMW (For USB Communication)	Teaching Box Model: SEL-TD PC-Supported Soft ware Model: IA-101-XA-MW (With RS232 Communication) Safety Category-Supported Cable)	
Input/Output and Communication	Standard Input/Output	Input: 16 points/Output: 16 points (NPN/PNP Selection Allowed)	Input: 24 points/Output: 8 points (NPN/PNP Selection Allowed)	Input: 32 points/Output: 16 points (NPN/PNP Selection Allowed)		
	Expanded Input/Output	Not Possible			Maximum Input: 192 Maximum Output: 192	
	Field Network	DeviceNet, CC-Link, ProfiBus	(Will be supported)	DeviceNet, CC-Link, ProfiBus, Ethernet		
General Specifications	Ambient Temperature/Humidity during Operation	0~40°C 10~95%(No condensation)				
	Ambient Air during Operation	No Corrosive gas. Especially no dust.				
	Outer Dimensions	72(W)×200.5(H)×121(D)	100(W)×202.6(H)×126(D) When the absolute battery is installed	340(W)×195(H)×125.3(D) (For 6-axis absolute specification)		
	Mass	1.1 kg	1.4kg	5.7kg(For 6-axis absolute specification)		
	Attachments	I/OFlat Cable(40 Cores)	I/OFlat Cable(34 Cores)	I/OFlat Cable(50 Cores)		

■ Brake Box (Attachment)

With the vertical types (MZMS/MZMML/ZMS/LZMM), this device must be installed while wiring the encoder between the controller and the actuator.

*This is not necessary with SZMS/SZMM.

(Attachment for models with brakes)

Model: RCB-110-RA13-0

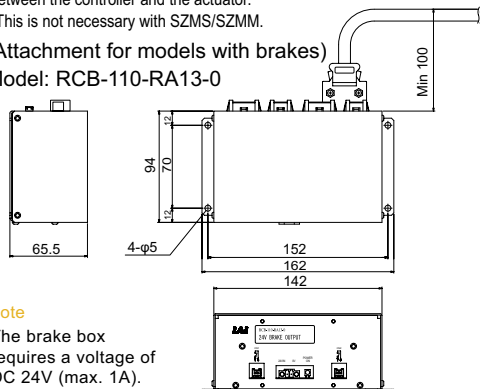

Note

The brake box requires a voltage of DC 24V (max. 1A).

■ Regenerative Resistance Unit (Optional)

■ Features This unit converts the regenerative current from a decelerating motor into heat. Refer to the following table to determine the required number of regenerative resistors according to the total wattage of the actuator.

■ Models
REU-1 (for XSEL)
REU-2 (for SCON/SSEL)

	Horizontal			Vertical		
	XSEL	SSEL	SCON	XSEL	SSEL	SCON
0	~100W	~200W	~100W	~100W	~200W	~100W
1	~500W	~800W	~400W	~800W	~600W	~400W
2	~800W			~1200W	~800W	~750W
3	~1200W			~1600W		
4	~2000W			~2000W		
5	~2400W			~2400W		

*Depending on the operating conditions, the number of regenerative resistors required may be larger than the number listed in the table above.
*If two regenerative resistance units are required for SCON/SSEL, use model REU-1 as the second unit.

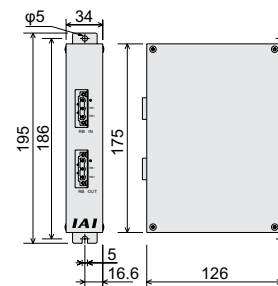

Maintenance Parts

Motor Cable (for XSEL-J/K/P/Q, SSEL, SCON)

Model: **CB-X-MA**□□□

*□□□ is for the cable length (L); supports up to 30m
Example: 080=8m

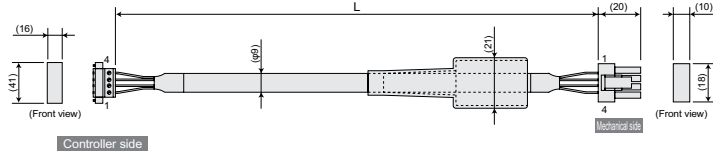

Wire	Color	Signal	No.	No.	Signal	Color	Wire
0.75sq	Green	PE	1	1	U	Red	0.75 sq Black (crimped)
	Red	U	2	2	V	White	
	White	V	3	3	W	Black (crimped)	
	Black	W	4	4	PE	Green	

Encoder Cable (For XSEL-P/Q, SSEL, SCON)

Model: **CB-X3-PA**□□□

*□□□ is for the cable length (L); supports up to 30 m.
Example: 080 = 8 m

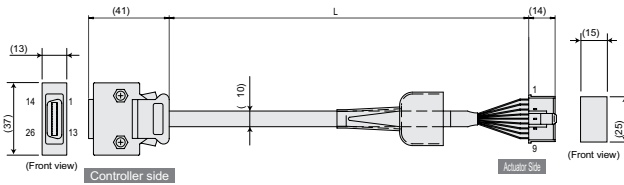

Wire	Color	Signal	No.	No.	Signal	Color	Wire
			10				
		E24V	11				
		OV	12				
		LS	26				
		CLEEP	25				
		OT	24				
		RSV	23				
			9				
			18				
			19				
		A+	1				
		A	2				
		B+	3				
		B	4				
		Z+	5				
		Z	6				
		SRD+	7				
		SRD	8				
		BAT+	14				
		BAT	15				
		VCC	16				
		GND	17				
		BKR	20				
		BKR+	21				
			22				

No.	Signal	Color	Wire
1	A	White/Blue	AWG26 (crimped)
2	A	White/Yellow	
3	B	White/Red	
4	B	White/Black	
5	Z	White/Purple	
6	Z	White/Grey	
7	LS+	White/Orange	
8			
9	FG	Drain	
10	SD	Orange	
11	SD	Green	
12	BAT+	Purple	
13	BAT	Gray	
14	VCC	Red	
15	GND	Black	
16	LS	White/Green	
17	BK	Blue	
18	BK+	Yellow	

The shield is clamped to the hood.
Drain wire and shield braid

Encoder Cable (for connecting devices with XSEL-P/Q, SSEL, SCON, LS)

Model: **CB-X2-PLA**□□□

*□□□ is for the cable length (L); supports up to 30 m.
Example: 080 = 8 m

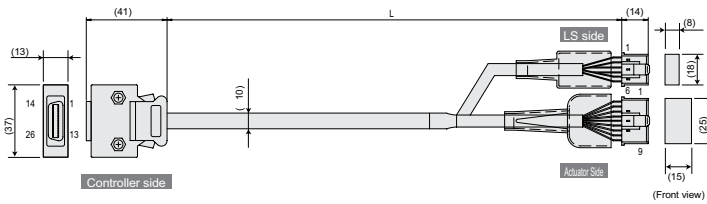

Wire	Color	Signal	No.	No.	Signal	Color	Wire
			10				
			11				
		E24V	12				
		OV	13				
		LS	26				
		CLEEP	25				
		OT	24				
		RSV	23				
			9				
			18				
			19				
		A+	1				
		A	2				
		B+	3				
		B	4				
		Z+	5				
		Z	6				
		SRD+	7				
		SRD	8				
		BAT+	14				
		BAT	15				
		VCC	16				
		GND	17				
		BKR	20				
		BKR+	21				
			22				

No.	Signal	Color	Wire
1	E24V	White/Orange	AWG26 (crimped)
2	OV	White/Green	
3	LS	Brown/Black	
4	CLEEP	Brown/Red	
5	OT	Brown/Black	
6	RSV	Brown/Black	
7			
8			
9	FG	Drain	
10	SD	Orange	
11	SD	Green	
12	BAT+	Purple	
13	BAT	Gray	
14	VCC	Red	
15	GND	Black	
16			
17	BK	Blue	
18	BK+	Yellow	

The shield is clamped to the hood.
Drain wire and shield braid

(Wire colors written as "White/Blue" indicate the band color/insulation color.)



IAI America, Inc.

Head Office 2690W 237th Street Torrance CA 90505
Chicago Office 1261 Hamilton Parkway Itasca, IL 60143
Atlanta Office: 1220 Kennestone Circle Suite E., Marietta,
GA 30066

IAI (Shanghai) Co., Ltd.

SHANGHAI JIAHUA BUSINESS CENTER A8404.808
Hongqiao Rd. shanghai 200030, China

www.intelligentactuator.com

The information contained in this product brochure may change without prior notice due to product improvements.

IAI Industrieroboter GmbH

Ober der Röth 4, D-65824 Schwalbach am Taunus, Germany

